

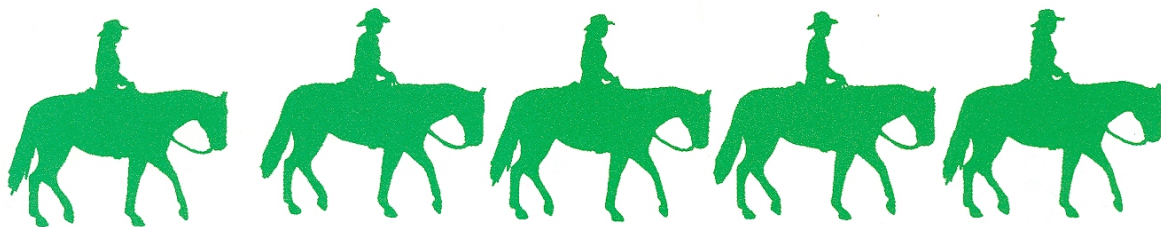

# **Texas 4-H Horse Show**

## **Rules and Regulations**

**2010**



# Foreword

This rule book establishes uniform regulations and procedures for qualifying for and participating in the Texas State 4-H Horse Show. These rules govern the State Show, the district shows, and all shows used to qualify contestants for district shows. Only the horse show component of the 4-H program is governed by these rules.

Classes that fit the majority of Texas 4-H members are offered in the State 4-H Horse Show program. Counties are encouraged to develop 4-H horse show activities according to local and county needs and situations. Local and county shows may include other classes where necessary, but such classes may not be used to qualify contestants for district shows.

This rule book is a revision of the original State Horse Show Rule Book, which was first developed in 1966 by Mr. B. F. Yeates, who is now retired and holds the designation of Extension Specialist Emeritus, Texas AgriLife Extension Service. This rule book is revised annually, or as necessary, by the Texas State 4-H Horse Show Committee. When you receive this book, discard copies of any previous editions of the Texas State 4-H Horse Show Rules and Regulations.

**Note: New rule revisions are highlighted with red and underlined made as per State 4-H Horse Committee recommendations.**

## Use of the Name and Emblem of 4-H

The use of the name and emblem of 4-H is regulated by federal law. This law states that only activities or programs under the supervision of the Texas AgriLIFE Extension Service may use the name and emblem of 4-H. Therefore, any local, county, district, area, or state 4-H horse show must have the approval of the Texas AgriLIFE Extension Service through county, district, or state personnel. Shows or events sponsored by other organizations or individuals and shows that do not provide separate classes for 4-H members are not permitted to use the name and emblem of 4-H. In such cases, the title "Junior Horse Show" or similar name should be used.

## Acknowledgments

Excerpts and illustrations have been used with permission from the official Handbook of the American Quarter Horse Association, Amarillo, Texas, and from the Handbook of the Stock Horses of Texas, Bryan, Texas.

### 4-H Horse Project Team

Brett D. Scott and Dennis Sigler, Extension Horse Specialists  
Teri Antilley, Extension Horse Program Specialist  
Texas AgriLIFE Extension Service  
The Texas A&M System

# Table of Contents

4-H Horse Program Objectives .....	5
General Rules and Regulations .....	6
Validation of Horses and Ownership.....	6
Miscellaneous Show Rules .....	7
Philosophy Statement.....	10
Show Point Systems .....	11
High Point Qualifying Division Awards .....	12
High Point Open Division Awards .....	12
4-H Horse Shows.....	12
Qualifying Division Classes.....	13
Open Division Classes.....	14
Hunter and Western Classes: Safety Helmets.....	14
Attire and Equipment: Western Performance Classes.....	15
Attire and Equipment: Hunter Performance Classes .....	17
Qualifying Division.....	19
Halter Division.....	19
Judged Western Division .....	20
Showmanship At Halter .....	20
Western Pleasure .....	22
Western Horsemanship .....	22
Western Riding .....	23
Western Trail .....	28
Futurity Division .....	33
General Futurity Rules.....	33
Yearling Halter.....	34
Yearling Longe Line.....	34
2-Year-Old Futurity .....	35
3-Year-Old Futurity .....	37
Speed Event Division.....	44
Pole Bending .....	44
Barrel Racing.....	44
Stakes Race .....	45
Hunter-Flat Division .....	45
Hunter Showmanship .....	45
Hunter Under Saddle.....	46
Hunt Seat Equitation.....	46

## Table of Contents (con't)

Open Division.....	48
Hunter Over Fences Division.....	48
Hunter Hack.....	48
Working Hunter.....	48
Open Jumping.....	50
Equitation Over Fences.....	52
Roping Division.....	52
General Rules.....	52
Tie-Down Calf Roping.....	53
Breakaway Roping.....	53
Team Roping.....	54
Stock Horse Division.....	54
Team Penning.....	54
Working Cow Horse.....	56
Cutting.....	61
Reining.....	61
Stock Horse Trail.....	70
Drill and Precision Division.....	73
General Rules.....	73
Drill Team.....	74
Precision Riding.....	74

# 4-H Horse Program Objectives

The objectives of the Texas 4-H Horse Program include providing means for 4-H members to:

1. Acquire horsemanship and horse-training skills.
2. Gain knowledge concerning science-related subjects, including horse production, management, training, evaluation and use.
3. Prepare for citizenship responsibilities and community service.
4. Develop leadership, initiative, self-reliance, sportsmanship, and other desirable life traits.

The Texas 4-H Horse Program accomplishes these objectives by offering projects and activities in horse management, production, training, and use. The four horse projects are:

- **Horsemanship:** Includes managing, riding, and training older horses with emphasis on learning the skills necessary to cause a horse to perform in a desirable fashion.
- **Training:** Includes managing and training 2- or 3-year-old horses. The project may also involve an older horse that needs further training or focus on advancing a horse to another event.
- **Weanling or Yearling Development:** Includes the management, conditioning, and training of a horse until the horse is old enough to be ridden.
- **Mare/Foal:** Includes managing a mare through the complete production cycle, from selecting the sire through weaning the foal.

The available activities vary from county to county. The major statewide activities and programs supporting horse projects are:

- **4-H Horse Show.** Shows are intended to provide a wholesome form of recreation and a forum for

demonstrating horsemanship and horse-training skills that lead to recognition and accomplishment. 4-H shows are also held for specific purposes, such as instructional shows, serving as clinics, and open shows, serving as fund-raising activities. Other shows are designed to qualify contestants for competition at the state level. Rules for these shows are found in the publication.

- **4-H Horse Judging.** All 4-H members are encouraged to learn how to evaluate horses. Judging knowledge provides the foundation for training, showing, buying, selling, and producing quality horses. This knowledge establishes the basis for the development of qualified horse show judges. Judging contests provide 4-H'ers with additional opportunities for achievement and recognition. Judging promotes decision-making, justification of thoughts, self-confidence, and public speaking. Rules for the State 4-H Horse Judging Contest are found in the *Texas 4-H Roundup Guide*.
- **4-H Horse Method Demonstration.** Demonstrations, or illustrated talks, challenge 4-H'ers to learn new skills and to share their new knowledge with others. 4-H'ers develop self-confidence and the ability to express themselves while demonstrating skills. *The Texas 4-H Roundup Guide* contains rules for the State Horse Method Demonstration Contest.
- **4-H Horse Record Book.** Records are the basis for many state and national awards. Record books provide an opportunity for 4-H'ers to record accomplishments depicting growth and development. *The 4-H Awards Handbook* contains rules for record book contests.
- **4-H Horse Bowl.** Horse Bowl challenges 4-H'ers to learn about the production, management, training, and

use of horses, in addition to other areas of the horse industry. Horse Bowl offers opportunities for recognition and achievement. Rules for the State 4-H Horse Bowl Contest are printed in *The 4-H Horse Bowl Guide* (AS 3-2.020) and the *Texas 4-H Roundup Guide*.

- **Hippology Contest.** Hippology activities encourage 4-H'ers to expand their background in judging, horse bowl and communication in an all encompassing contest. *Texas State 4-H Hippology Contest Guidelines*.
- **Other Projects.** Project areas such as photography, leadership, public speaking, vet science, clothing, and electricity complement a 4-H member's horse project.

## General Rules and Regulations

### Eligibility of Participants

1. **Bona fide 4-H Member:** A young person wishing to participate in the 4-H State Horse Show program must be currently enrolled in 4-H and must meet all the requirements established by the club and county programs.
2. **Member Age Requirement:** A contestant must be between the ages of 9 and 18 on August 31 or be 8 years old and entered (actually be attending) the third grade in school. A contestant must not have passed his or her nineteenth birthday before August 31 of the current year. (Clarification: A 4-H'er turning 19 on or before August 31 of a given year is not eligible to participate in the program the following year. A 4-H'er turning 19 on or after September 1 of a given year is eligible to participate for that 4-H year.) A 4-H year begins on September 1 and runs through August 31. At the district and state 4-H horse shows there will be no age divisions.

3. **4-H Horse Project Validation** – May 1 Required for Showing at District or State Horse Shows. May 1 is the deadline for a 4-H'er to validate a horse, which certifies that the project is owned by the 4-H'er or their sibling, parent, grandparent or legal guardian. The horse must be owned solely by the 4-H member, his/her parents (biological or stepparents), brother, sister, grandparents, or legal guardian. Horses under lease to, but not owned by any of the named persons, do not qualify. Horses owned in partnership or jointly with any person other than those previously listed do not meet ownership requirements. This process validates that the horse is owned and not leased, rented, loaned or borrowed. **Horses not validated on or before May 1 are ineligible for District and State 4-H Horse Shows.** Each 4-H horse project validated by a 4-H'er must be accompanied by a \$10.00 fee. County Extension offices complete the validation process with 4-H'ers on or by May 1<sup>st</sup>. A validation form must be filled out by the 4-H'er to include each horse being validated. CEA office personnel will collect those forms and a check from each 4-H'er for \$10.00/horse. **CEA offices have until May 8** to transfer the validation information and fees to the Horse Specialists' office. This transfer will be achieved using an excel spreadsheet that will be provided to the CEA's. Fees will be mailed. CEA offices will keep the Horse Validation Forms on file in their office for one year. Validation forms are available in the CEA Horse Newsletter (January issue). The check(s) must be sent to the Horse Specialists' office and made payable to the **'Texas 4-H Foundation - Horse Validation.'** Mail to: Horse Specialists' Office, Attn: Brett Scott, 2471 TAMU, College Station, TX 77843-2471.

**Note:** When validating projects, each horse must be represented by either 1) registration papers, or 2) Grade Horse Identification Certificate (available in January CEA Horse Newsletter). [Note: Registration papers within any breed (including any breeding stock)

associations make the horse a registered horse. If registered at any time in his/her life, even if appropriate transfers have not been kept up, the horse is a registered horse.] A Grade Horse Identification Certificate should describe the horse (size, age, sex, color, markings, and any other identifying characteristics), and be signed by the 4-H'er's parent or guardian, and County Extension Agent. The age of the horse is determined on the calendar year, starting on January 1 of the year foaled. (Also see page 8, No. 4)

4. **Futurity Validations:** All yearling halter, yearling long line, 2-year-old futurity and 3-year-old futurity projects must be nominated by **May 1**. The horse must be owned solely by the 4-H member, his/her parents (biological or stepparents), brother, sister, grandparents, or legal guardian. Horses under lease to, but not owned by any of the named persons, do not qualify. Horses owned in partnership or jointly with any person other than those previously listed do not meet ownership requirements. The Nomination form is included on the Validation form. To be eligible to show at the State Show, all nominated futurity horses **must show at the District 4-H Horse Show in the respective futurity class**. Futurity horses must be owned on or before **May 1** and must be validated by this date; additionally a Validation Form with the Futurity Horse Project section completed must be submitted by the May 1 deadline. All 4-H'ers who are nominating futurity project horses must be 12 years old or older as of September 1 of the current 4-H year (September 1, 2009 marks the start of 2010 year).
5. **Horse Ownership Deadline:** For participation in district and state shows and all shows used to qualify contestants for district shows, **the horse must be owned and validated as a 4-H project on or before May 1**. All transfer of ownership paperwork for horses must be completed prior to exhibiting at any show used to qualify contestants for district or state shows. Counties may establish shorter ownership time

requirements for local participation, including county qualifying shows. Under no circumstances should a horse be certified for district and state shows if it was not owned on or before May 1.

6. **Entry Forms for County, District, and State Shows:** County and district show entry forms are available from County Extension Agents. Registration papers or Grade Horse Identification Certificate documentation must be checked at the time a horse is entered in the first qualifying show of the year. State show entry forms are available at district shows and from local County Extension Agents. State Show entry forms are developed in the Horse Specialists' office and are distributed to all District Extension Offices.

## Miscellaneous Show Rules

The following rules and regulations, set forth by Texas AgriLife Extension Service, via the State 4-H Horse Committee, will apply at all levels of competition prior to and including the State Show and take precedence over any and all other rules.

1. At state and district shows, each contestant may enter one horse in **each Qualifying Division** and that horse must be ridden **or shown** only by that contestant. County situations may allow for a contestant entering more than one horse or for two or more riders competing on one horse, at a county show only. At District and State shows, no contestant or horse will be allowed to enter the same class twice. **In each of the Qualifying Divisions**, all points will be awarded on a one-horse, one rider basis. In each Open Division, all points will be awarded on one-or-more horse, one rider basis.
2. **Contestants at District and State may enter one or more horses in each of the Open Divisions; however, a horse cannot be entered or shown in an individual class more than once.**
3. At district and state shows, **a horse may be ridden by only one 4-H'er in a**

**Qualifying Division and by only one 4-H'er in an Open Division of the show. However, the same horse may be shown by one 4-H'er in one Qualifying Division and by another 4-H'er in another Qualifying Division, or by one 4-H'er in one Open Division and by another 4-H'er in an other Open Division, provided that the 4-H'ers are siblings, the ownership requirements are met, and the horse has been properly Validated as a 4-H project by all 4-H'ers (see validation rules). Exception: Drill and precision riding. In other words, siblings may share a horse at District or State Shows as long as the horse is shown in a division by only one 4-H'er, and is not shown in a class more than once. A horse may not go in the same class twice, and two 4-H'ers who are siblings cannot both ride the same horse in any one division, regardless of whether the division is Qualifying or Open. Futurity horses may never be ridden by more than one person.**

4. The age of the horse shall be computed on the basis of a calendar year starting January 1 of the year foaled. It is a weanling during the calendar year in which foaled and a yearling during the first calendar year following its foaling date, regardless of the time of year foaled. On January 1, all horses are considered to be one year older, regardless of actual birth date.
5. At the discretion of the county horse show committee, a 4-H member may be allowed to change horses between county and district shows, provided all horses involved meet **May 1** ownership requirements **and were properly validated**. It is recommended that, in hardship cases, this substitution is allowed. **Under no circumstances will horses be changed during a district show, and no change of horses will be allowed from district to state in any of the Qualifying Division classes.** A change of horses may be allowed for the Open **Division** classes, provided the horse was properly owned and **validated** on or before May 1.

6. If for some reason between the District and State shows, a 4-H drill team or precision riding member's May 1 certified horse cannot be used, he or she may substitute another May 1 certified and eligible horse. If a May 1 certified and eligible horse is not available, a 4-H'er may use any non May 1 certified horse, under a drill team or precision riding hardship situation. This hardship substitution situation must be documented in writing by the county agent and verified by an accompanying letter from a veterinarian. This documentation must be sent to the Horse Specialist's Office, pre-show, or brought to the State Show and given to the Horse Show Office at check-in.
7. **Districts shall not offer or hold novice classes during, or affiliated with the District Shows.**
8. **Exhibitors will be judged from the time they enter the arena until their performance is completed.**
9. The State Show will accept those qualifying 4-H members from each district **who actually exhibited in at least one class in a Qualifying Division. This allows that 4-H'er to enter all of the classes in that Division at the State Show.** Qualifiers must compete on the same horse they used at the district show.
10. Stallions **may not** be shown at district and state shows. If numbers warrant, counties may provide a class for weanlings and/or yearlings to encourage breeding projects.
11. Horses are not required to show at halter to be eligible to show in performance events.
12. Halter judging will be based on the horse only.
13. Showmanship is a performance event. It is suggested that showmanship precede halter classes. Large showmanship

classes should be worked in heats or individual runs with each exhibitor being scored for his or her performance. Heats should be small enough to be worked in approximately 30 minutes, so the class is not an endurance contest.

14. No rerun will be given to any contestant, if handicapped by the failure of his or her own equipment or an accident to the horse or rider.
15. In timed events, at least two watches should be used. The average time of the watches, used by the official timers, will be the official time. An electric timer is preferable and should be used at district and state shows.
16. Show Management decides whether exhibitors run from and/or to an open or closed gate, based on local arena conditions.
17. An exhibitor may not be assisted by any other person in the show ring, except in team classes (team penning, roping, etc.) **No exhibitor may be tied, buckled, or fastened in the saddle in any manner or by any means.** This does not apply to the preference by some timed event exhibitors to use rubber bands around boots, and although their use is discouraged, it is not prohibited.
18. When an exhibitor, exhibitor's parent, or person representing an exhibitor is guilty of poor sportsmanship or rude or unruly behavior, the show management, judge, or class superintendent may suspend such exhibitor's rights to participate in the class, future classes and/or shows for such a period as deemed appropriate.
19. A contestant may be disqualified from a class, at the judge's discretion, for receiving excessive verbal instructions from outside the ring while said exhibitor is performing.
20. A show official (show manager, judge, or class superintendent) may disqualify any horse or exhibitor from the competition for bad, unruly, and/or dangerous behavior.
21. Unsoundness may be penalized at the discretion of the judge. This decision is not subject to protest.
22. The use of any stimulants or depressants is prohibited. Any surgical procedure or drug that could affect a horse's performance or alter its natural conformation is prohibited. (Butazolidin use is legal.)
23. Any time a horse's mouth is tied or fastened in a performance class, the horse shall be disqualified. Any open, raw sores or bleeding body parts that come in contact with a hackamore, bit, spur, or other related equipment may be penalized at the judge's discretion.
24. The Texas State 4-H Horse Program is committed to the humane treatment of horses and cattle. Inhumane or abusive treatment may result in disqualification, at the discretion of the show management, members of the horse show management team, and/or judges.
25. The judge's decision shall be final and is not subject to protest.
26. A disqualified horse shall not be placed in a class (although it will be counted as an entry) in which the disqualification or "no score" occurred. The horse shall not receive points for disqualification in a class (exception: runoffs involving ties).
27. Scores are not official until verified with judges' cards and posted.
28. Exhibitors and exhibitors' parents are responsible for keeping track of working orders and for being in line or in the makeup arena when their run or heat time arrives. **Exhibitors who miss their heat or run will forfeit their run in that class, unless they notify the class superintendent of an unpreventable emergency before their time to work has passed and show management approves the request.**

29. Questions regarding the conduct of the show will be referred immediately to the show managers. The show managers will confer with the show officials, judge or class superintendent. If necessary, the show manager will give an on-the-spot decision that shall be accepted as final.
30. An appeals committee will be designated by the show management before the show begins. This committee will receive and act upon protests arising out of any class. A protest must be filed in writing, accompanied by a **\$ 200 cash fee**, during or immediately upon conclusion of the event. If the protest is upheld by the appeals committee, the deposit shall be refunded to the protester. If the protest is overruled, the deposit shall be forfeited to the horse show fund.
31. Class information (patterns, order, ground rules, etc.) will be posted 1 hour before the class starting time in a designated location close to the arena. It is the exhibitor's responsibility to be aware that this information is posted.
32. Exhibitors who stall their horses without paying or who stall their horses in unassigned stalls are subject to disqualification from the Texas State 4-H Horse Show.
33. Alcoholic beverages are prohibited on the show grounds.
34. Dogs are not allowed in facilities where horses are being exhibited. Violators may be subject to dismissal from the show.
35. Motorcycles, scooters, bicycles, skateboards, skates, golf carts, any motorized vehicle (excluding automobiles driven by licensed drivers) and other rolling vehicles are **prohibited on the grounds of the Taylor County Exposition Center during the State 4-H Horse Show. Taylor County Exposition Center prohibits their use during the State 4-H show.** Due to safety concerns, the State 4-H Horse Committee also unanimously supported the decision to prohibit their use at the State 4-H Horse Show.

**Exhibitors may be disqualified from the State 4-H Horse Show if they or their family members are found in violation. It is the responsibility of all exhibitors, family members and friends to make sure that such equipment is not used.** The only golf carts that will be allowed on the grounds will be those used by the staff of the Taylor County Exposition Center, the Official State Show Veterinarian, and the State Management Team. Any persons requesting the use of golf carts or other motorized apparatus due to handicap or disability must be able to provide documentation that such transportation is required, and this must be approved prior to use of the equipment on the grounds.

36. If an exhibitor dismounts for any reason other than a class requirement, they will receive a disqualification.
37. The fall of a horse or rider being judged shall be cause for disqualification in all classes. A horse is considered having fallen when he or she is on their side and all four feet are extended in the same direction. Rider is considered to have fallen when he or she is not astride.
38. At district and state shows, all exhibitors are asked to please refrain from allowing their horse(s) to be ridden by anyone other than the exhibitor. Many 4-H'ers have family members who will want to help hold, groom, saddle, and bridle horses in preparation for classes. This is encouraged, because family involvement is an important part of the 4-H Horse Program.

**Note:** Miscellaneous show rules 19 through 33 were submitted to TAMUS Legal Counsel for review and suggestions before being included in this rule book.

## Show Point Systems & Points Within Divisions

**System A.** District shows and the State Show will use System A. See Figure 1. District shows **should place first through tenth in all classes; however, they have option of placing through fifteenth in all classes.** County shows may use systems A, B, or C.

**System B.** For county shows. Each of the first 10 horses in a class will be given a point for each horse placing below it, plus one point. Points are calculated through tenth place.

**Example1:** In a class of 24 horses, the first place contestant receives 24 points; the second place gets 23 points; and so on down through tenth place.

**Example 2:** In a class of four horses, first place gets 4 points, second gets 3 points, third gets 2 points, and fourth gets 1 point.

**System C.** For county shows. Each of the first 10 horses in a class will be given a point for each horse placing below it, plus one point for a maximum of 10 points.

**Example:** In a class of 15, first place received 10 points, second receives 9 points, third receives 8 points, and so on through tenth place, which receives 1 point.

## Tie- Breaker Guidelines

### Tie Breakers (Individual Class Placings):

In the case of a tie in timed or scored classes, ties will be broken by the fastest time, highest score, or railwork in the finals. In all other classes (or should a tie still exist), a tie breaker judge shall be designated prior to the beginning of the class. (Note: finals run score to be used.) If a tie still exists or finals do not exist in a class, a runoff will be held for the top three places. In timed events, with the exception of roping events, the contestant declared the winner must run the pattern in no more than 2 seconds more than his/her original time or the runoff must be held again. Material awards for all other places will be decided by the flip of a coin; points will be split.

**Tie Breakers (High Points):** Break ties as follows: 1) total performance points, 2) placings in greater number of all classes, 3) greater number of horses placed over in all classes (within Division). If a tie still exists, contestants will be named Co-Champion and duplicate Champion awards will be provided at show management expense. No Reserve Champion will be named.

**Tie Breaker (Futurity Classes):** In the case of a tie in futurity classes, ties shall be broken first on the basis of the horse that placed the highest most often. If a tie still exists, it will be broken using the placing of the tie-breaker judge.

Points awarded for placing in class															
Contestants in class	1st	2nd	3rd	4th	5th	6th	7th	8th	9th	10th	11th	12th	13th	14th	15th
1-3	1														
4-7	2	1													
8-11	3	2	1												
12-15	4	3	2	1											
16-19	5	4	3	2	1										
20-24	6	5	4	3	2	1									
25-29	7	6	5	4	3	2	1								
30-34	8	7	6	5	4	3	2	1							
35-39	9	8	7	6	5	4	3	2	1						
40-44	10	9	8	7	6	5	4	3	2	1					
45-49	11	10	9	8	7	6	5	4	3	2	1				
50-54	12	11	10	9	8	7	6	5	4	3	2	1			
55-59	13	12	11	10	9	8	7	6	5	4	3	2	1		
60-64	14	13	12	11	10	9	8	7	6	5	4	3	2	1	
65 & over	15	14	13	12	11	10	9	8	7	6	5	4	3	2	1

Figure 1. System A, used for determining points at district shows and the Texas State 4-H Horse Show.

In yearling longe line, ties are broken first on the highest score in the longeing portion before considering conformation. If a tie still exists, tie-breaker judges' total score shall be used.

## High Point Qualifying Division Awards

**Champion Judged Horseman.** Most total points earned in the following classes: **showmanship at halter, western pleasure, western horsemanship, western riding and trail.** To be eligible for all Champion and Reserve Champion Judged Horseman Awards, **all points counted will be for one 4-H'er with one horse, as only one horse may be shown in these 5 classes that make up the division.**

**Champion Timed Horseman.** Most total points earned in the following classes: **pole bending, barrel racing, and stakes race.** (One horse/one rider). To be eligible for all Champion and Reserve Champion Timed Horseman Awards, a contestant must have placed (through tenth place) in at least two timed events.

**Champion Hunter-Flat Horseman.** Most total points earned with one horse in the following classes: Hunter Showmanship, Hunter under Saddle and Hunt Seat Equitation.

**Futurity Divisions.** Since there is only one class in each of the five Futurity Divisions, there are no High Point or Reserve High Point Awards in these divisions.

**Halter Division.** Since the first and second place horse from the mare and gelding classes come back to show for selection of grand and reserve champion, there are no other high-point awards in the halter division and halter points do not count toward high point in any of the other divisions at either district or state shows.

## High Point Open Division Awards

**Champion Hunter over Fences Horseman.** Most total points earned with one or more horses, one rider in Hunter Hack, Working Hunter, Equitation over Fences and Open Jumping.

**Champion Roper.** Is based on points in three roping classes. Must place (through tenth place) in more than one event. If no contestant places in more than one class, Champion Roper will be awarded to the person with the highest number of points in one class. Champion Roper is figured on a one or more horse(s)/one rider basis.

**Champion Stock Horseman.** Is based on points in cutting, reining, team penning, working cow horse and Stock Horse Trail. Must place (through tenth place) in more than one event. If no contestant places in more than one class, Champion Stock Horseman will be awarded to the person with the highest number of points in one class. Champion Stock Horseman is figured on a one or more horse(s)/one rider basis.

---

---

## 4-H Horse Shows

---

---

### Qualifying & Open Divisions

#### Qualifications

**County Qualifications:** All 4-H members meeting horse project requirements are eligible to compete. **All horses must have been validated by May 1<sup>st</sup>.**

**District Qualifications:** District shows may **accept** any number of county entries, or county quotas may be sent by the District Extension Director based on facilities and show schedule. Districts are encouraged to allow as many exhibitors as possible to compete in district shows.

**District Horse Show entry forms and procedures are provided to County Extension offices by the District Extension Office.**

**State Qualifications: In Qualifying Divisions, a 4-H'er must have shown at the District Show in a specific division to be eligible for that same division at State. In Open Divisions, there is no District qualification, in order to be eligible to enter those classes at State.**

## **Entries for State Show**

1. All contestants coming to district shows should be prepared to tell the show management whether or not they intend to participate in the State show if they qualify.
2. Districts **must** enter all qualifying contestants **using State 4-H Horse Show Entry Forms, updated annually by the State Horse Specialists' Office.**
3. State Show entries from districts are due in the Horse Specialists' Office in College Station by July 1. All entries must first go through the district office before being sent to the Horse Specialists' Office. No late entries will be accepted.
4. A 4-H'er who is already entered in the State Show by the July 1 deadline may make a class change or may add a class at the State Show for a \$50 fee. These class changes or class additions should be handled in person at the show in the horse show office. No changes will be accepted by phone during the period from July 1 until arrival at the State Show.
5. **No 4-H'er will be permitted to utilize a tack stall at the State 4-H Horse Show. This is due to the size of the show and demand for stall space. This is a space issue and a potential theft prevention issue. 4-H'ers are asked to help make sure tack stalls are not used during the show.**

## **District and State Show Qualifying Division Classes**

**District & State 4-H Horse Shows** - All 12 District 4-H horse shows offer these 22 classes in the following Qualifying Divisions. A 4-H'er must show in at least one class in

each division, in order to "Qualify" for that division(s) at the State 4-H Horse Show. A futurity project horse must also be shown at District in order to qualify for a futurity class at State.

### **Halter Division**

#### **(1 horse per 4-H'er)**

Registered Geldings 4 and Under

Registered Geldings 5 and Over

Grade Geldings

Grand & Reserve Champion Gelding

Registered Mares 4 and Under

Registered Mares 5 and Over

Grade Halter Mares

Grand & Reserve Champion Mare

### **Judged Western Division**

#### **(1 horse per 4-H'er)**

Showmanship at Halter

Western Pleasure

Western Horsemanship

Western Riding

Trail

### **Hunter-Flat Division**

#### **(1 horse per 4-H'er)**

Hunter Showmanship

Hunter Under Saddle

Hunt Seat Equitation

### **Speed Events Division**

#### **(1 horse per 4-H'er)**

Barrel Racing

Pole Bending

Stakes Race

### **Yearling Halter Gelding Futurity Division**

#### **(1 horse per 4-H'er)**

Yearling Halter Geldings

### **Yearling Halter Filly Futurity Division**

#### **(1 horse per 4-H'er)**

Yearling Halter Fillies

### **Yearling Longe Line Futurity Division**

#### **(1 horse per 4-H'er)**

Yearling Longe Line

### **2-Year-Old Futurity Division**

#### **(1 horse per 4-H'er)**

**Futurity Pleasure Pattern Class**

**Futurity Versatility Class**

**Futurity Western Pleasure Class**

### **3-Year-Old Futurity Division**

**(1 horse per 4-H'er)**

Stock Horse Pleasure Class

Stock Horse Trail Class

Stock Horse Reining Class

Stock Horse Cow Working Class

## **State Show Open Division Classes**

Some Districts also offer a variety of Open (Invitational) classes, and whether they are offered or not at a District show, a 4-H'er **is not** required to show in the following Open classes in order to enter those classes at State. They must, however, meet validation and entry deadlines, and for most Districts, that deadline for entering the State 4-H Horse Show is at the close of the District Show. Any 4-H'er not going to the District Horse Show, but planning to enter the following State 4-H Horse Show Open Division classes, must make arrangements with the County Extension Office to enter these classes prior to the District show date, to make sure they do not miss an entry cutoff date. Listed below are those classes that may or may not be offered at all District Horse Shows. If offered at District, they are still Open Division classes, and a 4-H'er **does not** have to show in these classes in order to enter them at the State 4-H Horse Show. **However, 4-H'ers are encouraged to support open division classes at District, and District Committees are encouraged to offer certain open classes according to interest level.**

### **Roping Division**

**(1 or more horses per 4-H'er, but only 1 horse per class)**

Tie-Down Calf Roping

Breakaway Roping

Team Roping

### **Hunter Over Fences Division**

**(1 or more horses per 4-H'er, but only 1 horse per class)**

Working Hunter

Equitation Over Fences

Hunter Hack

Open Jumping

### **Stock Horse Division**

**(1 or more horses per 4-H'er, but only 1 horse per class)**

Working Cow Horse

Team Penning

Reining

Cutting

Stock Horse Trail - Open to any horses not being shown in regular Western Trail.

### **Drill/Precision Riding Division**

Mounted Drill Team

Precision Riding Team

All State show entries from districts are due in the Horse Specialists' Office in College Station by July 1. All entries must first go through the district office before being sent to the Horse Specialists' Office. No late entries will be accepted. The Open Division show classes have no qualification procedures. Any 4-H member who meets the eligibility requirements and is certified by a County Extension Agent may enter the Open Division show classes. There is no limit to the number of classes a 4-H'er may enter or the number of horses he or she may show in the open division of the State Show. **However, refer to Miscellaneous Show Rules 1, 2, and 3.**

---

---

## **Performance**

---

---

### **Hunter and Western Classes: Safety Helmets**

During all over-fence classes and schooling over fence events it is **MANDATORY** that all riders wear properly fitted headgear with a fastened chin harness. During timed-event classes, it is strongly recommended that all riders wear properly fitted headgear with a fastened chin harness. In all other judged and timed classes, the use of protective headgear is acceptable, recommended, and the optional choice of the exhibitor. ASTM/SEI helmets are recommended. It is the responsibility of the rider and the parent, guardian, or trainer of the 4-H member to ensure that the headgear worn complies with appropriate safety standards for protective

headgear intended for equestrians' use, and that the headgear is properly fitted and in good condition.

The Texas AgriLife Extension Service, Texas State 4-H Horse Program and the District and State Horse Show Management Teams are not responsible for ensuring that the headgear worn complies with safety standards and make no representation or warranty, expressed or implied, about any protective headgear, and cautions riders that death or serious injury may result despite wearing such headgear, because all equestrian sports involve inherent dangerous risks, and no helmet can protect against all possible injuries.

## **Western Performance Classes: Attire and Equipment**

The use of protective headgear is the optional choice of exhibitors in any and all western classes, including judged, timed, and futurity classes.

### **Judged Classes (Excluding Futurities)**

Halter, western pleasure, western horsemanship, western showmanship, working cow horse, cutting, reining, western riding and trail:

**Attire.** Riders shall wear western hat, long-sleeve shirts and western boots. **Western boots shall include typical cowboy boots and lace-up ropers. All other footwear is prohibited. Any boot other than a leather sole boot is strongly discouraged.** The use of spurs and chaps shall be optional. Clothing should be neat and clean.

**Equipment.** Horses shall be shown in a stock saddle that fits the rider. Silver equipment will not count over good, clean, working equipment. Horses may be ridden with a curb, spade, or half-breed bit. **Split reins must be used and held in one hand with no more than one finger between the**

**reins.** When using a romal, no fingers between the reins are allowed. The free hand may not be used to adjust the rider's length of rein in any reining class. During reining, the use of the free hand while holding the romal to alter the tension or length of the reins from the bridle to the reining hand is considered to be the use of two hands and a score of 0 will be applied, with the exception of any place a horse is allowed to be completely stopped during a pattern. In all other classes, including the reined portion of working cowhorse, the free hand may be used to adjust the rider's length of rein.

Rationale for Rules on Bits, Bosals and use of Hands: The State 4-H Horse Committee is aware that these rules are not consistent with some major breed associations. The Texas 4-H horse program offers separate categories for young horses, often not available exclusively for youth in breed associations. 4-H'ers are encouraged to nominate, train and show 2- and 3-year-old horses in the futurity program. Futurity project offerings for 2-year-old and 3-year-old horses allow horses to be shown two-handed. Since the futurity project is available, extended use of 2- and 3-year-old horses in qualifying show classes is discouraged, simply due to the immature state of such horses. If a 4-H'er chooses to exhibit a futurity project horse in other qualifying classes, such as western pleasure or western horsemanship, those horses must be shown one-handed in a curb bit.

References to a bit in western performance classes mean the use of a curb bit that has a solid or broken mouthpiece, has shanks and acts with leverage. All curb bits must be free of mechanical device and should be considered a standard western bit. A description of a legal, standard western bit includes:

1. 8 1/2" (215 mm) maximum length shank to be measured as indicated in the diagram on page 16. Shanks may be fixed or loose.
2. Concerning mouthpieces, bars must be round, oval or egg shaped, smooth and unwrapped metal of 5/16" to 3/4"

(8 mm to 20 mm) in diameter, measured 1" (25 mm) from the cheek. They may be inlaid, but must be smooth or latex wrapped. Nothing may protrude below the mouthpiece (bar), such as extensions or prongs, including upward prongs on solid mouthpieces. The mouthpiece may be two or three pieces. A three-piece, connecting ring of 1 1/4" (32 mm) or less in diameter, or a connecting flat bar of 3/8" to 3/4" (10mm to 20 mm) measured top to bottom with a maximum length of 2" (50 mm), which lies flat in the horse's mouth, is acceptable.

3. The port must be no higher than 3 1/2" (90 mm) maximum, with rollers and covers acceptable. Broken mouthpieces, halfbreeds and spades are standard.
4. Slip or gag bits, and donut and flat polo mouthpieces are not acceptable.

ACCEPTABLE CHAIN CHIN STRAPS



WESTERN BITS

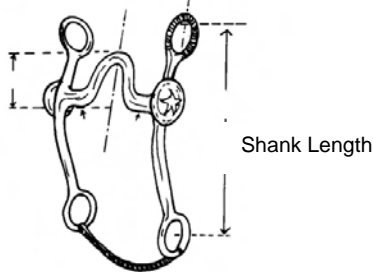

LEGAL BIT

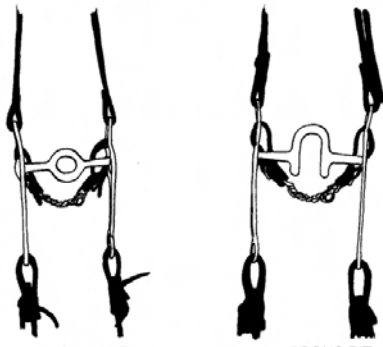

DONUT BIT

ILLEGAL BITS

PRONG BIT

Curb chains or straps must be at least 1/2 inch in width and must lie flat against the horse's chin. No wire curbs are permitted, regardless of the amount of padding or tape. Absolutely no iron will be permitted under jaws. Mechanical hackamores are prohibited. Bosals or nosebands are not permitted with a bit. Gag bits, tie downs, martingales, and draw reins are prohibited.

**Protective boots and leg wraps are not allowed in halter, showmanship at halter, western pleasure, western riding or trail.**

## Timed Event Classes

Pole bending, barrel racing, stakes race, calf roping, breakaway roping, team roping, and team penning:

**Attire.** Exactly like judged classes. **Long-sleeve shirts and western boots are required. Boots other than leather soled boots are discouraged.** Western hat is optional, and, if worn, should be affixed in a manner to keep it from coming off the rider. Caps are prohibited.

**Equipment.** Western-type equipment must be used. The use of a mechanical hackamore, gag bit, or other type of bridle is the contestant's choice. However, the officials or judge may require the removal or alteration of equipment considered severe, dangerous, or inhumane. Contestants may use tie downs.

## 2-Year-Old Futurity

**Attire.** Same as other judged classes.

**Equipment.** Horses must be shown two-handed, in either a smooth snaffle or a bosal. Any bit having shanks, and therefore curb action of any type, is prohibited. **References to snaffle bits in futurity classes mean the conventional O-ring, egg-butt or D-ring with a ring no larger than 4" (100 mm). The inside circumference of the ring must be free of rein, curb or headstall attachments which**

would provide leverage. The mouthpiece should be round, oval or egg-shaped, smooth and unwrapped metal. It may be inlaid, but smooth or latex wrapped. The bars must be a minimum of 5/16" (8 mm) in diameter, measured one inch (25 mm) in from the cheek with a gradual decrease to center of the snaffle. The mouthpiece may be two or three pieces. A three-piece, connecting ring of 1 1/4" (32 mm) or less in diameter, or a connecting flat bar of 3/8" to 3/4" (10 mm to 20 mm) measured top to bottom, with a maximum length of 2" (50 mm), which lies flat in the horse's mouth, is acceptable. Optional curb strap attached below the reins on a snaffle bit is acceptable.

Split-reins are mandatory with snaffle bits. Two methods of holding the reins are acceptable. One rein may be held in each hand, or both reins may be held with both hands. If one rein is held in each hand, the tail of each rein must lay across the horse's neck.

If a hackamore (bosal) is used, it must be a flexible, braided rawhide, leather or rope bosal, the core of which may be either rawhide or flexible cable. Absolutely no rigid material will be permitted under the jaws, regardless of how padded or covered. Horse hair bosals are prohibited. This rule does not refer to a so-called mechanical hackamore.

There should be approximately 1 1/2 inches between the bosal and nose. A continuous hackamore rein is permitted. Mechanical hackamores, gag bits, twisted-wire snaffles, martingales, tie downs, and draw reins are prohibited.

***Protective boots and leg wraps are not allowed.***

### **3-Year-Old Futurity**

**Attire.** Same as other judged classes.

**Equipment.** Horses must be shown two-handed in a smooth snaffle as previously described for 2-year-old futurity horses. Hackamores (bosals) are not permitted.

Gag bits, twisted-wire snaffles, martingales, tie downs, and draw reins are prohibited.

## **Hunter Performance Classes: Attire and Equipment**

### **Judged Classes**

Hunter showmanship, hunter under saddle, hunt seat equitation, hunter hack, working hunter, open jumping, hunt seat equitation over fences:

**Attire.** See the section entitled Hunter and Western Classes Safety Helmets on page 14. Clothing must be clean and neat. The rider must wear a coat, boots, breeches, and hunting cap. The coat may be any tweed or melton (conservative, washable jackets in season) acceptable for hunting, such as navy, dark green, gray, black or brown. Maroon and red are not acceptable. Breeches or jodhpur pants should be traditional shades of buff, brown, khaki, canary, light gray or rust. Boots may be black or brown. A black, dark blue, or brown hard-hat is required. A tie or choker is required. Spurs of the unrowelled type, gloves, crops, and bats are optional. Gloves are preferred in the equitation class and should be heavy wash leather or brown leather. Judges or show management may authorize adjustments to attire because of weather. See the section on Hunter Showmanship for specific attire and equipment.

**Equipment.** Traditional hunting or forward-seat-type saddles shall be used and should be black and/or brown leather. A knee insert on the skirt is optional. Saddle pads should fit size and shape, except when necessary to accommodate exhibitor numbers on both sides, for which a square pad or suitable attachment may be used. Saddle pads should be white or natural color with no ornamentation.

In all English classes, an English snaffle (no shank), kimberwick, pelham and/or full bridle (with two reins), all with cavesson

nosebands and plain leather brow bands must be used.

In reference to mouthpieces, nothing may protrude below the mouthpiece (bar). Solid and broken mouthpieces must be between 5/16" to 3/4" (8 mm to 20 mm) in diameter, measured 1" (25 mm) from the cheek and may have a port no higher than 1 1/2" (40 mm). They may be inlaid, synthetic wrapped, including rubber or plastic or incased, but must be smooth. On broken mouthpieces only, connecting rings of 1 1/4" (32 mm) or less in diameter or connecting flat bar of 3/8" to 3/4" (10 mm to 20 mm) measured top to bottom with a maximum length of 2" (50 mm), which lie flat in the horse's mouth, are acceptable. Snaffle bit rings may be no larger than 4" (100 mm) in diameter. Any bit having a fixed rein requires use of a curb chain. Smooth round, oval or eggshaped, slow twist, corkscrew, single twisted wire, double twisted wire mouthpieces and straight bar or solid mouthpieces are allowed.

In the open jumping class only, mechanical hackamores may be used.

Bits of any style (pelham, snaffle, kimberwick) featuring mouthpieces with cathedrals, donuts, prongs, edges or rough, sharp material shall be cause for elimination. Square stock, metal wrapped or polo bits shall be cause for elimination. If a curb bit is used, the chain must be at least 1/2" (15 mm) in width and lie flat against the jaw of the horse.

Breastplates are optional. Martingales are not allowed in flat classes or hunter hack. Draw reins, hackamores, boots, or bandages are all prohibited (exception: boots or leg wraps are legal in open jumping).

### Acceptable English Bits For All Ages

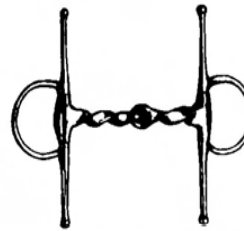

Slow Twist

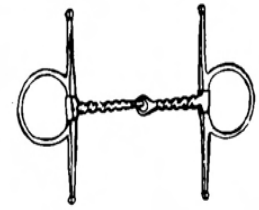

Corkscrew

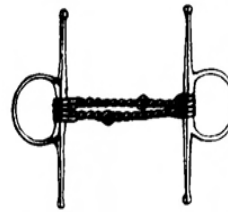

Double Twisted Wire

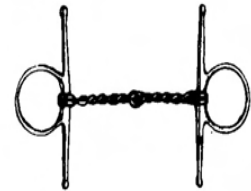

Single Twisted Wire

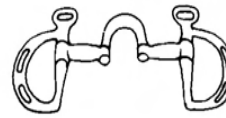

Correction Bit



Snaffle Bit with  
Connecting Flat Bar

### Unacceptable English Bits

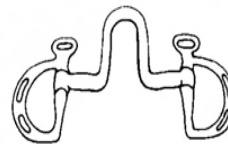

Excessive Port

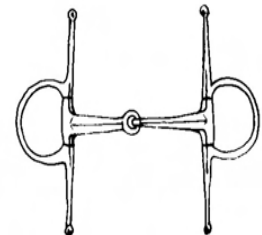

Triangular Mouth

## Qualifying Division Class Rules

### Halter Division

A halter class is defined as a class where the horse is judged based upon its conformation.

The purpose of the class is to select individuals in the order of their resemblance to the breed ideal and that are the most positive combination of balance, structural correctness, breed and sex characteristics and muscling.

The ideal halter horse has eye appeal that is the result of a harmonious blending of an attractive head; refined throat latch; well-proportioned, trim neck; long, sloping shoulder; deep heart girth; short back; strong loin and coupling; long hip and croup; and well-defined and muscular stifle, gaskin, forearm and chest. These characteristics should be coupled with straight and structurally correct legs and feet that are free of blemishes. The horse should be a balanced athlete that is muscled uniformly throughout.

Conformation is defined as the physical appearance due to the arrangement of muscle, bone and other body tissues.

One of the most important criteria in selecting a horse is conformation, or its physical appearance. While it could be assumed that most horses with several years seasoning and past performance have acceptable conformation, the goal in selection should always be to find the best conformed horse possible.

Rating conformation depends upon objective evaluation of four traits: balance, structural correctness, breed and sex characteristics, and degree of muscling. Of the four, balance is the most important and refers to the structural and aesthetic blending of body parts. Balance is influenced almost entirely by skeletal structure.

## Equipment

**Lip chains: Mares and geldings may not be shown with any chain through the mouth including but not limited to lip chains.**

### Judging Procedure

Horses will walk to the judge one at a time. As the horse approaches, the judge will step to the right (left of the horse) to enable the horse to trot straight to a cone placed at 50 feet (15 meters) away. It is at the judge's discretion whether horses will trot straight past this cone or turn left and continue trotting. After trotting, horses will be lined up head to tail for individual inspection by the judge. The judge shall inspect each horse from both sides, front and rear.

The judge should line the horses to be paced in a head-to-tail order according to preference.

When judging of all classes in a halter division has been completed, all first- and second-place class winners of that sex division shall return to the ring, with first-place class winners in one line and second-place horses from each class in another line.

The judge must select a Grand Champion and Reserve Champion in each sex division.

The judge(s) shall select the Grand Champion mare or gelding from the first-place class winners in the respective sex division. If the first-place horse does not return for any reason, the second-place horse will move up to the first-place line and be considered for Grand and Reserve. The third-place horse cannot move up to second place in the class.

The second-place horse in the class from which the Grand Champion had been selected will be judged with the first-place class winners for the title of Reserve Champion mare or gelding in the respective sex division.

## Performance Class Rules

### Judged Western Division

#### Showmanship at Halter

The showmanship class is judged on an exhibitor's ability to execute practical and basic halter class maneuvers from the ground. The class should always be judged with this in mind, giving credit to the exhibitor who can correctly perform each maneuver of the total pattern or run. Judges should refrain from conducting the class routine in any manner that attempts to trick, confuse, or mislead exhibitors. In showmanship at halter, conformation of the horse is not judged.

**Attire.** Exhibitors should be neat, clean, and well-groomed. Clothing shall be as stated in the section on judged classes. Chaps and spurs are not permitted in showmanship.

**Equipment.** Use a clean halter that is adjusted to fit the horse. The halter should fit well on the horse's head to maximize response to subtle halter cues. Silver halters shall not count over a nice, clean, well-fitted halter. Lead straps are often attached to a chain and snap. The lead strap may be snapped below the jaw in the center ring of the halter, or the chain can be run under the horse's chin and snapped to the upper or lower halter ring on the right side of the horse's head.

#### Horse Fitting and Grooming

1. The horse should be clean and well-groomed. Manner of fitting for mane and tail may vary according to recognized practices for a particular breed of horse.
2. A well-groomed horse that is clean, properly trimmed, and conditioned does have a justified advantage in showmanship at halter. Underweight or thin horses may be penalized.

#### Method of Showing

1. Walk, trot, turn, stop, back, and pose the horse as shown in the posted pattern or by the judge's instructions.
2. The horse is always led from the left side. The exhibitor's right hand is held closest to the halter, with the distance being highly dependent upon the mannerisms of the horse, the size of both the horse and the exhibitor, and breed standards. The excess amount of lead is folded or loosely coiled in the left hand and held about waist high. Never wrap the excess lead around the hand or make a coil so small that a sudden jerk could cause the lead to wrap around the hand.
3. At both the walk and the trot, the exhibitor's shoulder should be about even with the horse's throatlatch. In this position, the horse is beside the exhibitor, allowing the judge a clear view of the horse's travel. Movement at both gaits should be brisk and sharp, as opposed to slow and dull. Speed of travel is somewhat related to straightness of travel, and the slower a horse moves, the greater chance for deviation from a straight line of movement.
4. When leading to or from a judge or ringmaster, stops and turns are very important. The exhibitor should always allow plenty of space between the horse and the judge. Stops should be executed squarely and without hesitation, as the stop is an important maneuver preceding a correct turn or reverse of direction.
5. Turns of more than 90 degrees should always be executed to the right. Pushing the horse away rather than pulling the horse around will allow more distance between the horse's and the exhibitor's feet. In addition, turning to the right allows the horse to use the right hind foot as a pivot point. The horse can then cross the left front

foot over the right front to execute a very uniform and smooth turn. This results in the horse remaining in essentially the same tracks after the turn is completed and provides the judge a good view as the horse is walked or trotted away.

6. Immediately following a turn or reverse of direction, the exhibitor should look back to make sure the horse is lined up with the judge. Class routines may require walking or trotting back into the lineup of horses. The exhibitor should lead all the way through the line, stop, reverse, and then lead into the line to set up. If asked to change positions in the line, back the horse out of the line, and approach the new position from behind.
7. Pose or set up the horse with its feet set according to its type or breed. Stock horse breeds stand square. Move the horse's feet by pushing or pulling on the lead strap as necessary with the right hand. Touching the horse's body with a hand or foot to change the horse's position is penalized.
8. Once set up, the horse should be presented in such a way as to not distract the judge's attention from the horse. The exhibitor stands on the opposite side of the horse when the judge is toward the front and on the same side as the judge when the judge is toward the rear of the horse. This method of presentation is preferred by most judges for youth exhibitors.
9. For safety reasons, at no time should an exhibitor stop and stand directly in front of the horse.
10. The primary objective is to show the horse. Exhibitors should stand where they can see the judge and the judge can see them, but without obstructing the judge's view of the horse. The basic position of the exhibitor should allow constant observation of the

horse's position and also permit observation of the judge.

11. Staring at the judge keeps an exhibitor from continually observing the horse and keeping the horse set properly. Exhibitors should maintain eye contact with the horse. It is acceptable to glance at the judge from time to time, but an exhibitor should not do this continuously.
12. Exhibitors should keep their proper position in line and allow reasonable space (at least 5 feet) between horses on either side. Keep horses from making contact with a competitor or encroaching on space rightfully belonging to another exhibitor.

### **Some Showmanship Class Faults**

1. Allowing the horse to remain out of position.
2. Standing directly in front of the horse.
3. Kicking the horse's feet to move them.
4. Failure of the horse to lead properly.
5. Failure to stop before turning when showing at a walk or trot.
6. Failure to back.
7. Loud voice commands to the horse or other unnecessary actions.
8. Picking up the horse's feet for positioning purposes.
9. Tracking crooked.
10. Posing incorrectly.

### **Class Routine**

1. Exhibitors may enter the arena single-file, moving around the arena counter-clockwise before lining up at the judge's

instruction. Once in line, each exhibitor will perform individually.

2. At many shows, exhibitors will be asked to enter the arena individually and work a pattern designed by the judge.
3. Regardless of the manner used, judges should draw patterns clearly and make instructions that are easily understood by exhibitors.
4. Where patterns are posted, such instructions should be available for the exhibitor to review prior to the start of this class (at least 1 hour before, if possible).

## **Western Pleasure**

This class recognizes a horse for functional correctness, quality of movement, attitude, and manners.

1. Horses are shown at a walk, jog, and lope on a reasonably loose rein without undue restraint. Horses must work both ways of the ring, at all three gaits, to demonstrate their ability with different leads and transitions. Riders may be asked to extend the jog at the judge's discretion. An extended jog is a definite two-beat lengthening of stride and covering more ground. Cadence and balance with smoothness is more essential than speed. Lope with forward motion will be the only gait recognized as a lope. Horses may be required to reverse at the walk or jog and to go from any gait to another gait at the discretion of the judge. For safety of the exhibitors, a reverse at a lope or extended jog shall not be called.
2. Horses should back easily and stand quietly. The judge may ask that only finalists be backed.
3. Horses are to be reversed to the center of the arena.
4. Large numbers in this class may require qualification heats to

accommodate all horses. Arena size will dictate heat size. After each heat, all horses should be brought to the center with the finalists identified.

5. Any portion of a class or heat may be placed on the rail for extra work by the judge at any time.
6. At no time shall a fault-out system that results in exhibitors being eliminated individually be used. A positive approach should be used, the winners or finalists being announced and the remainder of the class being dismissed from the arena as a group. Individual horses should not be pulled off the rail while the class is being judged.
7. Entries shall be penalized for being on wrong leads, but not necessarily disqualified. Excessive speed and breaking gait are to be penalized. Horses with a low head carriage and/or head carriage behind the vertical and/or a sullen, lethargic, emaciated, drawn, or tired look will be penalized.
8. The class will be judged on the performance and condition of the horse at the discretion of the judge.

## **Western Horsemanship**

This class recognizes the exhibitor's ability to ride a horse functionally and correctly using various aids to cause the horse to perform required basic maneuvers.

## **General**

1. Riders will be judged on basic position in the saddle, which includes the position and use of hands, seat, feet, and legs, as well as the ability to control and show the horse.

2. Scores on individual works will be based on rider's skills and execution of the pattern.

### **Position**

1. Arms and hands. Arms and hands should be held in an easy, relaxed manner. Upper arms are held in a straight line with the body, with the arm holding the reins bent at the elbow. Only one hand is used for reining, and hands shall not be changed on the reins. The hand is to be around the reins with one finger permitted between split reins. Reins are to be carried immediately above and slightly in front of the saddle horn. Reins should be held so that light contact is maintained with the horse's mouth.
2. Basic position. The rider should sit in a comfortable, balanced, relaxed, and flexible manner. The lower leg should hang straight down from the knee or forward to the stirrups with a slight bend in the knee, depending on the type of saddle. In either position, stirrups should be just long enough for heels to be lower than toes. The feet should be placed in the stirrups with the boot heel touching the stirrup or slightly less deep. Riding with the weight on the toes will be penalized. The toes should be turned only slightly out, with the ankles flexed in a comfortable position. The lower legs and feet should be kept close to the horse's body, but not in contact except when applying aids.

### **Position in Motion**

The rider shall sit the jog and not post. The rider should be close to the saddle at a lope. Exaggerated shifting of the rider's weight is not desirable and will be penalized in judging.

### **Class Routine**

1. The judge will ask each rider to work individually. Individual works will be a

combination of maneuvers that the judge feels are necessary to determine the horsemanship ability of the rider. The pattern must include only maneuvers from the following list:

- a. straight walk, jog, and lope, and circles in both directions.
  - b. stop.
  - c. back straight, in an "L", and in a circle.
  - d. 360-degree turn or spin.
  - e. pivot, both ways.
  - f. turns of 90, 180 or 270 degrees.
  - g. rollbacks
  - h. lope circles of varying size and speed.
  - i. pick up leads from standstill, walk, or jog.
  - j. simple lead changes on a straight away or in a circle.
  - k. side pass.
  - l. counter canter.
  - m. two track.
2. The pattern should be posted at least 1 hour before the class begins, if at all possible.
  3. The judge will use these individual work scores to determine the top riders who will be asked to work individually or on the rail. Selected riders (or all riders if the class is small) will be required to work on the rail to determine final placing. Rail work is optional for the State Show and may or may not be held.
  4. Rail work will include walk, jog, and lope in one or both directions of the ring at the discretion of the judge.

### **Western Riding**

Western riding is neither a stunt nor a race, but it should be done with reasonable speed. It is a competition of the performance of a sensible, well-mannered, free, and easy-moving horse through and over obstacles.

1. Horses will be judged on quality of gaits (walk, jog, and lope), lead

changes, response to the rider, manners, and disposition.

The judge and exhibitors must adhere to the prescribed patterns. See Patterns 1, 2, 3, and 4.

- a. In a Western Riding event, the horse is judged on quality of gaits, lead changes at the lope, response to the rider, manners and disposition. The horse should perform with reasonable speed and be sensible, well-mannered, free and easy moving.
- b. Credit shall be given for and emphasis placed on smoothness, even cadence of gaits (i.e., starting and finishing pattern with the same cadence) and the horse's ability to change leads precisely, easily and simultaneously, both hind and front, at the center point between markers. The horse should have a relaxed head carriage showing response to the rider's hands, with a moderate flexion at the poll. Horses may be ridden with light contact or on a reasonably loose rein. The horse should cross the log both at the jog and the lope without breaking gait or radically changing stride.
- c. The judge will select one of the four patterns to be performed. The judge is responsible for the pattern being correctly set.
- d. On the pattern:
  1. The small circles represent the recommended pylon markers. These should be separated by a uniform measured distance of not less than 30 feet (9 meters) nor more than 50 feet (15 meters) on the sides with five markers (see diagram). In pattern one, the three markers on the opposite side should be set across from the appropriate markers. It is recommended that markers be set a minimum

of 15 feet (4 ½ meters) from the fence and with 50- to 80- foot (15 to 24 meters) width in the pattern, as the arena permits.

2. A solid log or pole should be used and be a minimum of 8 feet (2.5 meters) long.
  3. The long serpentine line indicates the direction of travel and gait at which the horse is to move. The shaded area represents the lead changing area between the markers. The dotted line (...) indicates walk, the dash line (---) jog, and the solid line (-) lope.
- e. Scoring will be on a basis of 0-100, with 70 denoting an average performance.
    1. Scoring guidelines: Points will be added or subtracted from the maneuvers on the following basis, ranging from plus 1.5 to minus 1.5: -1.5 extremely poor, -1 very poor, -0.5 poor, 0 average, +0.5 good, +1 very good, +1.5 excellent. Maneuver scores are to be determined independently of penalty points.
  - f. A contestant shall be penalized each time the following occur:

### **Five points**

1. Out of lead beyond the next designated change area (note: failures to change, including cross-cantering. Two consecutive failures to change would result in two five-point penalties.)
2. Blatant disobedience including kicking out, biting, bucking and rearing.

### **Three points**

1. Not performing the specific gait (jog or lope) or not stopping when called for in the pattern, within 10 feet (3 meters) of the designated area.
2. Simple change of leads.
3. Out of lead at or before the marker prior to the designated change area or out of lead at or after the marker after the designated change area.
4. Additional lead changes anywhere in pattern (except when correcting an extra change or incorrect lead).
5. In patterns one and three, failure to start the lope within 30 feet (9 meters) after crossing the log at the jog.
6. Break of gait at walk or jog for more than two strides.
7. Break of gait at the lope.
2. Willful abuse.
3. Off course.
4. Knocking over markers.
5. Completely missing log.
6. Major refusal – stop and back more than two strides or four steps with front legs.
7. Major disobedience or schooling.
8. Failure to start lope prior to end cone in patterns one and three.
9. Four or more simple lead changes and/or failures to change leads.
10. Overturn of more than ¼ turn.

### **Credits**

#### **One point**

1. Hitting or rolling log.
2. Out of lead more than one stride either side of the center point and between the markers.
3. Splitting the log (log between the two front or two hind feet) at the lope.
4. Break of gait at the walk or jog up to two strides.

1. Changes of leads, hind and front simultaneously.
2. Change of lead near the center point of the lead change area.
3. Accurate and smooth pattern.
4. Even pace throughout.
5. Easy to guide and control with rein and leg.
6. Manners and disposition.
7. Conformation and fitness.

#### **One-half point**

1. Tick or light touch of log.
2. Hind legs skipping or coming together during the lead change.
3. Non-simultaneous lead change. (Front to hind or hind to front.)

- g. The following characteristics are considered faults and should be judged accordingly in maneuver scores.
  1. Opening mouth excessively.
  2. Anticipating signals.
  3. Stumbling.

#### **Disqualified – 0 score**

1. Illegal equipment.

## Western Riding Pattern 1

1. Walk at least 15 feet and jog over log.
2. Transition to left lead and lope around end.
3. First line change.
4. Second line change.
5. Third line change.
6. Fourth line change lope around the end of arena.
7. First crossing change.
8. Second crossing change.
9. Lope over log.
10. Third crossing change.
11. Fourth crossing change.
12. Lope up the center, stop and back.

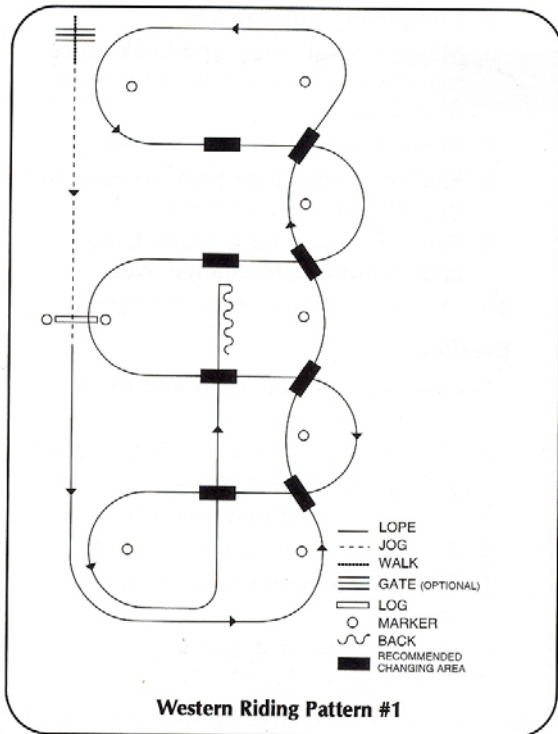

## Western Riding Pattern 2

1. Walk, transition to jog, jog over log.
2. Transition to the lope, on the left lead.
3. First crossing change.
4. Second crossing change.
5. Third crossing change.
6. Circle and first line change.
7. Second line change.
8. Third line change.
9. Fourth line change and circle.
10. Lope over log.
11. Lope, stop and back.

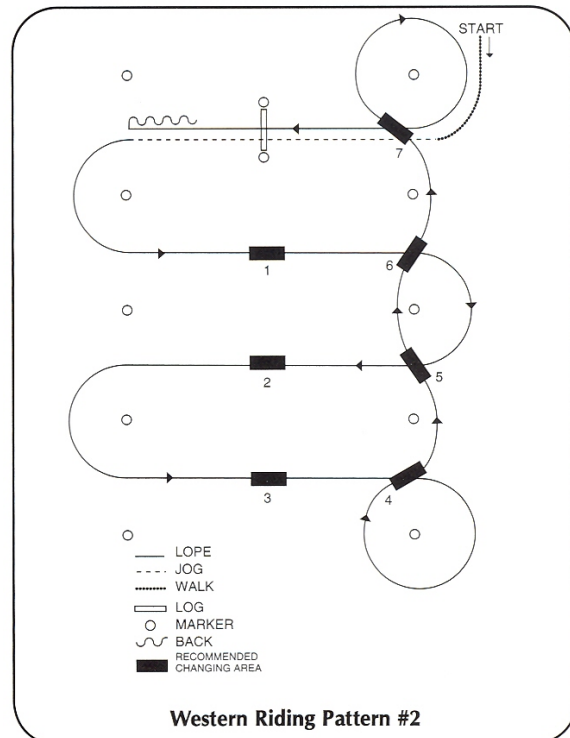

### Western Pattern 3

1. Walk halfway between markers, transition to jog, jog over log.
2. Transition to the lope, on the left lead.
3. First crossing change.
4. Lope over log.
5. Second crossing change.
6. First line change.
7. Second line change.
8. Third line change.
9. Fourth line change.
10. Third crossing change.
11. Fourth crossing change.
12. Lope up the center, stop and back.

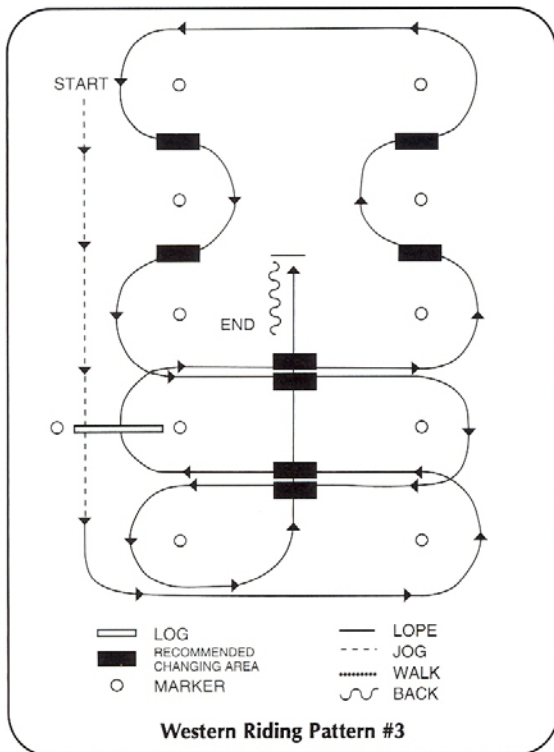

### Western Riding Pattern 4

1. Walk, transition to jog, jog over log.
2. Transition to the lope, on the right lead.
3. First line change.
4. Second line change.
5. Third line change.
6. Fourth line change.
7. First crossing change.
8. Second crossing change.
9. Third crossing change.
10. Lope over log.
11. Lope, stop and back.

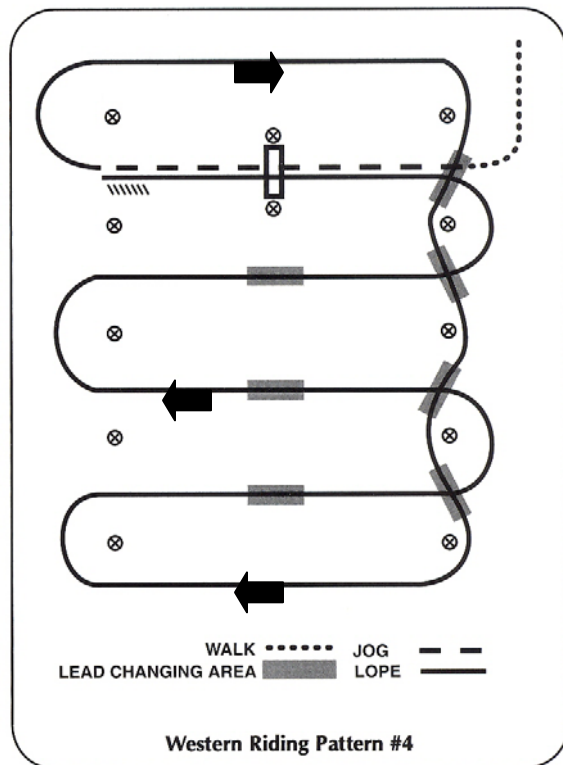

## Western Trail

This class will be judged on the performance of the horse over obstacles, with emphasis on manners, response to the rider and quality of movement. Credit will be given to horses negotiating the obstacles with style and some degree of speed, providing correctness is not sacrificed. Horses should receive credit for showing attentiveness to the obstacles and the capability of picking their own way through the course when obstacles warrant it and willingly responding to the rider's cues on more difficult obstacles.

1. Horses shall be penalized for any unnecessary delay while approaching or negotiating the obstacles. Horses with artificial appearance over obstacles should be penalized.
2. Horses must not be required to work on the rail. The course must be designed, however, to require each horse to show the three gaits (walk, jog, lope) somewhere between obstacles as a part of its work, and quality of movement and cadence should be considered as part of the maneuver score. While on the line of travel between obstacles, the horse shall be balanced, carrying his head and neck in a relaxed, natural position, with the poll level with or slightly above the withers. The head should not be carried behind the vertical, giving the appearance of intimidation, or be excessively nosed out, giving a resistant appearance. Gait between obstacles shall be at the discretion of the judge.
3. The course to be used must be posted at least one hour before scheduled starting time of the class.
4. Scoring will be on the basis of 0-infinity, with 70 denoting an average performance. Each obstacle will receive an obstacle score that should be added or subtracted from 70 and is subject to a penalty that should be subtracted. Each obstacle will be

scored on the following basis, ranging from plus 1½ to minus 1½: -1½ extremely poor, -1 very poor, -½ poor, 0 correct, +½ good, +1 very good, +1½ excellent. Obstacle scores are to be determined and assessed independently of penalty points. Penalties should be assessed per occurrence as follows:

- A. The following deductions will result:

### 0 – SCORE

- 1) Use of more than one finger between reins
- 2) Use of two hands or changing hands on reins; only one hand may be used on the reins, except that it is permissible to change hands to work an obstacle.
- 3) Illegal use of romal
- 4) Performing the obstacles incorrectly or other than in specified order
- 5) No attempt to perform an obstacle
- 6) Equipment failure that delays completion of pattern
- 7) Excessively or repeatedly touching the horse on the neck to lower the head
- 8) Fall to the ground by horse or rider
- 9) Failure to enter, exit or work obstacle from correct side or direction, including overturns of more than 1/4 turn
- 10) Failure to work an obstacle in any manner other than

how it's described by the course

11) Riding outside designated boundary marker of the arena or course area

12) Third refusal

13) Failure to demonstrate correct lead or gait, if designated

14) Faults that occur on the line of travel between obstacles, which will be cause for disqualification, which shall be faults scored according to severity:

a) head carried too low (tip of ear below the withers *consistently*)

b) over-flexing or straining neck in head carriage so the nose is carried behind the vertical *consistently*.

#### **1/2 POINT**

1) Each tick of log, pole, cone or obstacle

#### **1 POINT**

1) Each hit of or stepping on a log, pole, cone or obstacle

2) Incorrect gait at walk or jog for two strides or less

3) Both front or hind feet in a single-strided slot or space

4) Skipping over or failing to step into required space

5) Split pole in lope-over

6) Failure to meet the correct strides on jog over and lope over log obstacles

#### **3 POINT**

1) Break of gait at walk or jog for more than 2 strides

2) Out of lead or break of gait at lope (except when correcting an incorrect lead)

3) Knocking down an elevated pole, cone, barrel, plant obstacle, or severely disturbing an obstacle

4) Stepping outside the confines of, falling, or jumping off or out of an obstacle with one foot

#### **5 POINT**

1) Failure to follow the correct line of travel within or between obstacles

2) Dropping slicker or object required to be carried on course

3) First refusal, balk, or attempting to evade an obstacle by shying or backing more than 2 strides away

4) Second refusal

5) Letting go of gate or dropping rope gate

6) Use of either hand to instill fear or praise

7) Stepping outside the confines of, falling, or jumping off or out of an obstacle with more than one foot

- 8) Blatant disobedience (kicking out, bucking, rearing, striking)
  - 9) Failure to complete obstacle
  - 10) Faults, which occur on the line of travel between obstacles, scored according to severity:
    - a) excessive nosing out
    - b) opening mouth excessively
5. Management, when setting courses, should keep in mind that the idea is not to trap a horse, or eliminate it by making an obstacle too difficult. All courses and obstacles are to be constructed with safety in mind, so as to eliminate any accidents. When the distances and spaces are measured between all obstacles, the inside base to inside base measurement of each obstacle considering the normal path of the horse should be the measuring point. Enough space must be provided for a horse to jog (at least 30 feet) and lope (at least 50 feet) for the judges to evaluate these gaits.
6. If disrupted, the course shall be reset after each horse has worked. In the case that a combination of obstacles is used, the course cannot be reset until the contestant finishes the entire course, regardless of where any disruption occurs.
7. At least six obstacles must be used, three of which must be from the mandatory list of obstacles, and at least three others selected from the list of optional obstacles.
8. Mandatory obstacles:
- A. Opening, passing through and closing gate. (Losing control of gate is to be penalized.) Use a gate which will not endanger horse or rider. If the gate has a metal, plastic or wooden support bar under the opening, contestants must work the gate moving forward through it.
  - B. Ride over at least four logs or poles. These can be in a straight line, curved, zig-zag or raised. The space between the logs is to be measured, and the path the horse is to take should be the measuring point. All elevated elements must be placed in a cup, notched block, or otherwise secured so they cannot roll. The height should be measured from the ground to the top of the element. Spacing for walk overs, jog overs, and lope overs should be as follows or increments thereof.
    - 1) The spacing for walk overs shall be 20" to 24" (40 cm to 60 cm) and may be elevated to 12" (30 cm). Elevated walkovers should be set at least 22" (55 cm) apart.
    - 2) The spacing for jog overs shall be 3' to 3'6" (90 cm-105 cm) and may be elevated to 8" (20 cm).
    - 3) The spacing for lope overs shall be 6' to 7' or increments thereof, and may be elevated to 8".
    - 4) It is highly recommended that patterns for District Horse shows contain both jog overs and lope overs in order to better prepared trail class exhibitors for state show.

- C. Backing obstacle. Backing obstacles to be spaced a minimum of 28" (70 cm). If elevated, 30" (75 cm) spacing is required. Entrants cannot be asked to back over a stationary object such as a wooden pole or metal bar.
  - D. Back through and around at least three markers.
  - E. Back through L, V, U, straight or similar-shaped course. May be elevated no more than 24" (60 cm).
9. Optional obstacles, but not limited to:
- A. Water hazard (ditch or small pond). No metal or slick bottom-boxes will be used.
  - B. Serpentine obstacles at walk or jog. Spacing to be minimum of 6' (1.8 meters) for jog.
  - C. Carry object from one part of arena to another. (Only objects which reasonably might be carried on a trail ride may be used.)
  - D. Ride over wooden bridge. (Suggested minimum width shall be 36" (90 cm) wide and at least six feet long). Bridge should be sturdy, safe and negotiated at a walk only.
  - E. Put on and remove slicker.
  - F. Remove and replace materials from mailbox.
  - G. Side pass (may be elevated to 12" (30 cm) maximum).
  - H. An obstacle consisting of four logs or rails, each 5' to 7' (1.5 to 2.1 meters) long, laid in a square. Each contestant will enter the square by riding over log or rail as designated. When all four feet are inside the square, rider should execute a turn, as indicated, and depart.
  - I. Any other safe and negotiable obstacle which could reasonably be expected to be encountered on a trail ride and meets the approval of the judge may be used.
  - J. A combination of two or more of any obstacle is acceptable.
10. Unacceptable obstacles:
- A. Tires
  - B. Animals
  - C. Hides
  - D. PVC pipe
  - E. Dismounting
  - F. Jumps
  - G. Rocking or moving bridges
  - H. Water box with floating or moving parts
  - I. Flames, dry ice, fire extinguisher, etc.
  - J. Logs or poles elevated in a manner that permits such to roll
  - K. Ground ties
11. The judge must walk the course prior to the start of the class and has the right and duty to alter the course in any manner. The judge may remove or change any obstacle they deem unsafe or non-negotiable. If at any time a trail obstacle is deemed to be unsafe by the judge, it shall be repaired or removed from the course. If it cannot be repaired and horses have completed the course, the score for that obstacle shall be deducted from all previous works for that class.

# Trail Examples

## Back Through and Around Three Markers

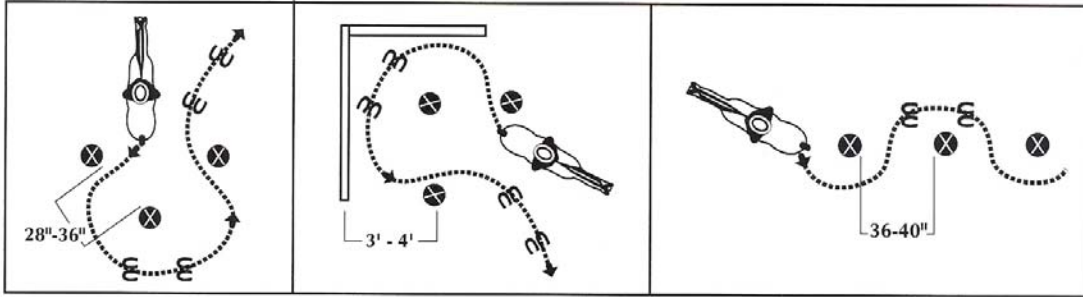

## Back Through and Around Three Markers

## Trot Overs, Lope Overs

## Walk Overs

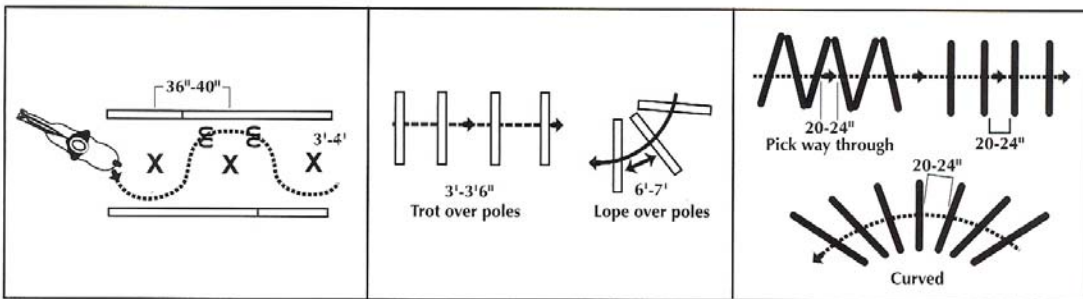

## Variations of Sidepass

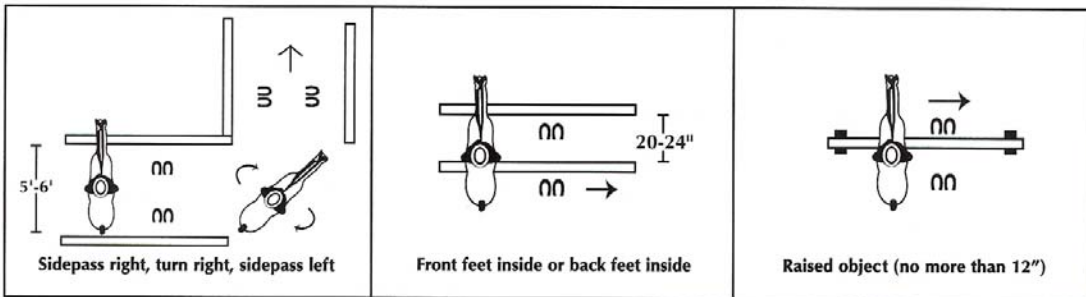

## Variations of Sidepass

## Variations of L Back Through

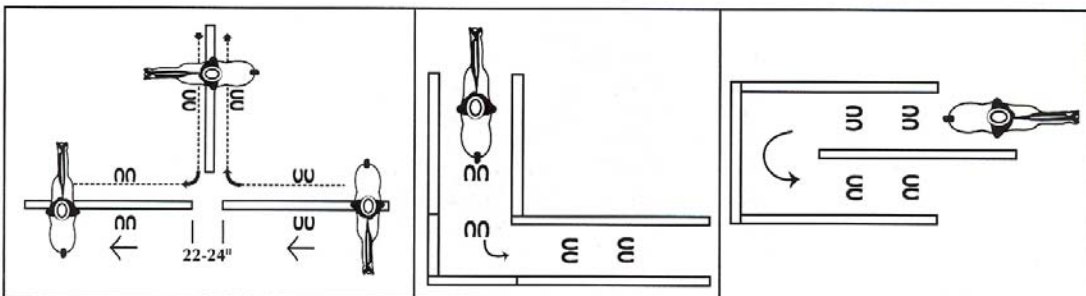

## Futurity Division Classes

All 4-H'ers nominating futurity project horses must be at least 12 years old or older as of September 1, of the current 4-H year. To be eligible for State Show Futurity classes, a 4-H'er must show in the Futurity classes at the District show.

The Texas 4-H Horse Program offers five futurities to 4-H horse exhibitors as follows:

1. Yearling Halter Geldings: stock-type.\*
2. Yearling Halter Fillies: stock-type.\*
3. Yearling Longe Line: for fillies or geldings of any breed.\*
4. 2-Year-Old Futurity: for 2-year-old geldings or fillies (any breed of horse) to be shown in a snaffle bit or bosal.
5. 3-Year-Old Futurity: for 3-year-old geldings or fillies (any breed of horse) to be shown in a snaffle bit.

\* **Note:** A yearling may be nominated for halter only, halter and longe line, or longe line only.

**All futurity projects must be officially validated by May 1, with paperwork turned into the county office.**

**Philosophy:** Older horses are desirable for young and/or beginning 4-H members to help them acquire knowledge and skill prior to attempting a training project. In showing an older horse effectively, a rider acquires some training skills, and these foundational skills help prepare a 4-H'er for handling a training project. The futurity classes provide a challenge and recognition for older experienced members. In 2010, all 4-H'ers nominating futurity projects must be 12 years old or older as of September 1 of the current 4-H year.

### General Rules for Futurities

1. Horses must be solely owned by 4-H members, their parents (biological or

step), brother, sister, grandparents, or legal guardian.

2. Horses must be in 4-H member's possession and under his or her management and care by **May 1**.
3. Members may validate more than one horse for each or all of the futurities; however, a 4-H member may show only one horse in each futurity.
4. Members validate horses for the futurities by completing a **4-H Member Horse Validation Form with the Futurity Horse Section completed**. This validation form must be certified (signed) by the County Extension Agent. **Futurity validations must be in the county Extension office no later than May 1. The County Extension Agent will assemble all futurity nomination forms for that county, attach them to a county summary sheet, and mail them to the State Extension Horse Specialists' office, postmarked no later than May 5. No late entries will be accepted.** A list of horses **validated** for each futurity will be published after the **validation** deadline. **Validation** does not constitute a show entry and nominated horses must still be entered in the State Show.
5. Futurity horses are to be ridden two-handed in either a smooth snaffle or a bosal (2-year-old futurity) or a smooth snaffle (3-year-old futurity). Refer to specific futurity project attire and equipment rules in Western Performance Class attire and equipment section (page 15).
6. Members with properly **validated** horses enter their project(s) in the State 4-H Horse Show by paying show entry fee(s) prior to the State Show.
7. Futurity horses may be shown prior to the State 4-H Horse Show; however, after the horse becomes a futurity project on **May 1**, it can be ridden or shown only by the 4-H member.

8. Advice and counsel on fitting, developing, and/or training techniques may come from outside sources. With yearlings, individuals other than the 4-H'er may assist with grooming, but only the 4-H'er can show the horse at any and all horse shows after **May 1**. **With yearlings validated for longe line, the actual process of longeing the horse on a longe line constitutes training. Therefore, after May 1, the yearling longe line horse can be worked on a longe line only by the 4-H'er.** Family members are not to ride or show yearling, 2-year-old or 3-year-old futurity horses at any time after **May 1**.

## Yearling Halter Futurities

### Equipment

**Lip chains: Mares and geldings may not be shown with any chain through the mouth including but not limited to lip chains.**

### Judging Procedure

Horses will walk to the judge one at a time. As the horse approaches, the judge will step to the right (left of the horse) to enable the horse to trot straight to a cone placed at 50 feet (15 meters) away. **It is at judge's discretion whether horses will trot straight past this cone or turn left and continue trotting.** After trotting, horses will be lined up head to tail for individual inspection by the judge. The judge shall inspect each horse from both sides, front and rear.

The judge should line the horses to be paced in a head-to-tail order according to preference.

## Yearling Longe Line Futurity

1. The Yearling Longe Line class is a preparatory class for yearlings that may eventually be nominated as 2-year-old futurity or 3-year-old futurity horses.

2. Yearling longe line prospects must be nominated and entered through the same process as 2- and 3-year-olds in the futurity horse program.
3. The longe line class is held separately from yearling halter futurity competition. Separate awards are given.
4. The horses are to be shown in a flat nylon or leather halter, with a longe line 20 to 30 feet long. Use of a longe whip is optional.
5. The snap on the longe line may include a chain extension which can be attached to the halter under the horse's chin, or the chain may be run through a side D and under the horse's chin. Chains are not permitted over the horse's nose or in the horse's mouth. Bridles are not permitted.
6. Attire may be either English or Western.

Western: The 4-H'er shall wear a Western hat and western boots. Long-sleeved shirts are required. Clothing should be neat and clean. Gloves are optional.

English: The 4-H'er shall wear a coat, boots, breeches, and hunting cap appropriate to Hunter classes and described on page 17. Gloves are optional.

Whether in English or Western attire, the use of protective headgear is the optional choice of the exhibitor, as described on 14.

### Class Routine

1. The arena will have a designated exhibition area. No assistance may be provided by grooms, once a horse enters the arena.
2. Each 4-H'er will have 2 minutes to exhibit his or her yearling. A whistle or announcement will signal the end of the 2-minute exhibition. At the completion of the 2 minutes, the 4-H'er and the

- horse will leave the working area. After all horses are worked, they will be brought back in and lined up for a final inspection.
3. Yearling longe line horses should be shown in both directions on the longe line and should attempt to show all three gaits in each direction. The order in which the gaits are shown is the choice of the exhibitor. Failure to show all three gaits shall not be cause for disqualification, but shall be scored accordingly.
  4. Longe whips, if carried, should be used to provide encouragement and to aid in positioning the horse on the longe line. Excessive use of the longe whip can be cause for disqualification.
2. All horses in this class will be shown two-handed in a smooth snaffle bit or a bosal.
  3. The 2-Year-Old Futurity Division will consist of three separate classes, a 2-Year Old Futurity Pleasure Pattern class, a 2-Year- Old Futurity Versatility class and a traditional Western Pleasure class. At the State Show, only a limited number of riders will be called back for the Western Pleasure Class as this will be considered the finals of the 2-Year Old Futurity.
  4. Overall placing will be determined by the composite placing of all three classes.
  5. All equipment and attire must conform to the specified rules and regulations.
  6. Omitting a maneuver is not grounds for disqualification, but the omitted maneuver receives a score of 0.

### **Scoring**

1. One or two judges will be used. If two judges are used, their scores will be added together. If possible, judges who will not be judging the halter futurity will be used to judge the longe line class.

Scoring will be computed as follows:

- a. 40 percent for mechanical correctness of longeing procedures and the response of the horse on the longe line.
- b. 40 percent for quality of movement.
- c. 20 percent for conformation.

### **2-Year Old Futurity**

**THIS ENTIRE CLASS IS NEW AND ALL TEXT SHOULD BE CONSIDERED TO BE RED.**

1. All 2-Year Old Futurity horses must be nominated and entered through the same process as the yearlings in the futurity horse program.

### **2-Year-Old Futurity Pleasure Pattern Class**

This class serves to measure the ability of the horse to be functional and a pleasure to ride while being used as a means of conveyance from one western stock horse task to another. This horse should be well-broke, relaxed, quiet, soft and cadenced at all gaits. The horse should be ridden on a relatively loose rein with light contact and without requiring undue restraint. Excessively long floppy reins will not be given extra credit. The horse should be responsive to the rider and make all required transitions smoothly, timely and correctly. The horse should be soft in the bridle and yield to contact.

Horses shall be shown individually at the walk, trot and lope in both directions. The trot and lope will be extended in one direction only. Markers setup in the arena will designate gait changes. The pleasure course shall be set to make approximately one pass of the arena in each direction. The pattern

may be started either in the left or right direction. The order of gaits shall be:

- 1) walk,
- 2) trot,
- 3) extended trot,
- 4) lope,
- 5) stop and reverse,
- 6) walk,
- 7) lope,
- 8) extended lope,
- 9) trot, and
- 10) stop and back.

The extended trot may be ridden with the rider either posting or standing in the stirrups to the front of the saddle. Holding the saddle horn is permissible, at the extended trot. The reverse may be executed in either direction.

### **Scoring 2-Year-Old Futurity Pleasure Pattern Class**

Part of the evaluation of this class is on smoothness of transitions. All transitions should be smooth with willingness and responsiveness to the rider's cues. Note that the rules allow for a horse to be taken back (collected) a bit from the extended trot as the horse moves into the lope. The transition from the extended lope down to the trot is very difficult to achieve; however, a good stock horse should be able to make this transition smoothly, easily, with calmness and a good attitude.

Each gait, including transitions, will be scored from 1-10. There will be 5 scores in each direction for a total of 10 scores and a maximum of 100 points for each horse's work.

The scoring guide for each maneuver, including transitions, is as follows:

1-4 Points ..... Major faults such as wrong lead, broken gait, lack of control, very poor quality of gait, failure to perform requested gait.

5-7 Points ..... Average quality of movement of gaits and transitions with minor or no faults.

8-10 Points .... High quality mover that is functionally correct in gaits and transitions. Well-mannered and responsive.

## **2-Year-Old Futurity Versatility Class**

### **Class Routine**

1. The judge will ask each rider to work individually. Individual works will be a combination of maneuvers that the judge feels are necessary to determine the brokenness and manners of the horse/rider combination. The pattern must include only maneuvers from the following list:
  - a. straight walk, jog, and lope, and/or circles in both directions.
  - b. stop.
  - c. back straight, in an "L", and in a circle.
  - d. 360-degree turn or spin.
  - e. pivot, both ways.
  - f. turns of 90, 180 or 270 degrees.
  - g. rollbacks
  - h. lope circles of varying size and speed.
  - i. pick up leads from standstill, walk, or jog.
  - j. simple lead changes on a straight away or in a circle.
  - k. side pass.
  - l. trot around or through cones.
  - m. two track.
  - n. walking and/or trotting over logs.
2. The pattern should be posted at least 1 hour before the class begins, if at all possible.
3. Scores on individual works will be based on rider's skills, the brokenness/manners of the horse and execution of the pattern.

## **2-Year-Old Futurity Western Pleasure Class**

This class recognizes a horse for functional correctness, quality of movement, attitude, and manners.

1. Horses are shown at a walk, jog, and lope on a reasonably loose rein without undue restraint. Horses must work both ways of the ring, at all three gaits, to demonstrate their ability with different leads and transitions. Riders may be asked to extend the jog at the judge's discretion. An extended jog is a definite two-beat lengthening of stride and covering more ground. Cadence and balance with smoothness is more essential than speed. Lope with forward motion will be the only gait recognized as a lope. Horses may be required to reverse at the walk or jog and to go from any gait to another gait at the discretion of the judge. For safety of the exhibitors, a reverse at a lope or extended jog shall not be called.
2. Horses should back easily and stand quietly.
3. Horses are to be reversed to the center of the arena.
4. Numbers in this class may require multiple heats to accommodate all horses. Arena size will dictate heat size. After each heat, all horses should be brought to the center with the finalists identified.
5. Any portion of a class or heat may be placed on the rail for extra work by the judge at any time.
6. At no time shall a fault-out system that results in exhibitors being eliminated individually be used. A positive approach should be used, the winners or finalists being announced and the remainder of the class being dismissed from the arena as a group. Individual horses should not be pulled

off the rail while the class is being judged.

7. Entries shall be penalized for being on wrong leads, but not necessarily disqualified. Excessive speed and breaking gait are to be penalized. Horses with a low head carriage and/or head carriage behind the vertical and/or a sullen, lethargic, emaciated, drawn, or tired look will be penalized.
8. The class will be judged on the performance and condition of the horse at the discretion of the judge.

## **3-Year- Old Futurity**

**THIS ENTIRE CLASS IS NEW AND ALL TEXT SHOULD BE CONSIDERED TO BE RED.**

This class has been revised to provide a more challenging project for older, more experienced 4-H'ers and to provide more opportunities for a wider range of youth from across the entire state. Rules for judging have been rewritten to provide a more meaningful evaluation of 3-Year-Old Horse Projects and to promote overall "brokenness" of horses.

1. The 3-Year-Old Futurity class is an advancement class to follow the 2-Year-Old Futurity class.
2. All 3-Year-Olds must be nominated and entered through the same process as are 2-Year-Olds and yearlings in the futurity horse program.
3. All horses in this class will be shown two-handed in a smooth snaffle bit. Bosals are not permitted.
4. To emphasize the all-around, versatile, stock horse, the class will consist of four separate parts (Stock Horse Pleasure, Stock Horse Trail, Stock Horse Reining, Stock Horse Cowhorse) with the overall placing

being determined by the combination of all four parts. There will be no working finals.

5. The horses are to be scored on each required maneuver of the stock horse pleasure pattern. The horses will be scored from 0 to 10 on each maneuver with a class, respectively.
6. Omitting a maneuver is not grounds for disqualification, but the omitted maneuver receives a score of 0.
7. At the discretion of the judges, an exhibitor taking excessive time or unable to negotiate a maneuver may be motioned on to the next maneuver. Riders taking excess time in starting/completing a maneuver (i.e., back through) will be asked to pass on and will receive a score of 0 on that maneuver.

### **Stock Horse Pleasure Class**

This class serves to measure the ability of the horse to be functional and a pleasure to ride while being used as a means of conveyance from one western stock horse task to another. This horse should be well-broke, relaxed, quiet, soft and cadenced at all gaits. The horse should be ridden on a relatively loose rein with light contact and without requiring undue restraint. Excessively long floppy reins will not be given extra credit. The horse should be responsive to the rider and make all required transitions smoothly, timely and correctly. The horse should be soft in the bridle and yield to contact.

Horses shall be shown individually at the walk, trot and lope in both directions. The trot and lope will be extended in one direction only. Markers setup in the arena will designate gait changes. The pleasure course shall be set to make approximately one pass of the arena in each direction. The pattern may be started either in the left or right direction. The order of gaits shall be:

- 1) walk,
- 2) trot,
- 3) extended trot,

- 4) lope,
- 5) stop and reverse,
- 6) walk,
- 7) lope,
- 8) extended lope,
- 9) trot, and
- 10) stop and back.

The extended trot may be ridden with the rider either posting or standing in the stirrups to the front of the saddle. Holding the saddle horn is permissible, at the extended trot. The reverse may be executed in either direction.

### **Description of Ideal Pleasure Gaits**

The ideal pleasure horse will have a level head carriage at each gait – neither too high nor too low.

**Walk** – A stock horse pleasure walk should be straight, square, flat footed, relaxed and should move out freely with horse looking ahead.

**Trot** – This gait should be a square two-beat diagonal trot. The trot should be steady, soft and slow enough for riding long distances. Trots which are too fast, rough and hard to sit should be penalized. Excessively slow and uncadenced trot should also be penalized.

**Extended Trot** – The extended trot should show a definite lengthening of stride from the regular trot with the same cadence, which will cause an increase in speed. This trot should be level, flat and steady with the appearance that the horse could hold this gait for an extended distance.

**Lope** – This gait should be a three-beat gait that is collected, cadenced, straight and steady and is comfortable to ride.

**Stop** (from both lope and trot) – The horse should be in the correct stopping position – both hocks engaged and stopping on the hindquarters.

**Reverse** – A horse should turn briskly and flat with front feet on the ground and holding an inside rear pivot foot.

**Extended Lope** – This gait should be an obvious lengthening of stride from the previous lope, be at the same cadence and cause an increase in speed. The gait needs to be steady, quiet, and holding the increased speed while being under complete control.

Part of the evaluation of this class is on smoothness of transitions. All transitions should be smooth with willingness and responsiveness to the rider's cues. Note that the rules allow for a horse to be taken back (collected) a bit from the extended trot as the horse moves into the lope. The transition from the extended lope down to the trot is very difficult to achieve; however, a good stock horse should be able to make this transition smoothly, easily, with calmness and a good attitude.

### **Scoring Stock Horse Pleasure**

Each gait, including transitions, will be scored from 1-10. There will be 5 scores in each direction for a total of 10 scores and a maximum of 100 points for each horse's work.

The scoring guide for each maneuver, including transitions, is as follows:

- 1-4 Points ..... Major faults such as wrong lead, broken gait, lack of control, very poor quality of gait, failure to perform requested gait.
- 5-7 Points ..... Average quality of movement of gaits and transitions with minor or no faults.
- 8-10 Points .... High quality mover that is functionally correct in gaits and transitions. Well-mannered and responsive.

### **Stock Horse Trail Class**

The trail class, as the name implies, tests the horse's ability to cope with many situations encountered in everyday work. The horse is ridden through a pattern of obstacles

which should nearly approximate those encountered during the course of everyday work. The horse is judged on the cleanliness, neatness and promptness with which the obstacles are negotiated, ability to negotiate obstacles correctly and attitude and mannerisms exhibited by the horse while negotiating the course. Emphasis on judging should be on identifying the well-broke, responsive, well-mannered horse which can correctly negotiate the course. The object is not to trap a horse, or eliminate it by making an obstacle too difficult. All courses and obstacles are to be constructed with safety in mind so as to eliminate any accidents.

1. Course will include no less than six and no more than nine obstacles. It is mandatory that the horse be asked to walk, trot and lope during the course.

Walk – can be part of obstacle score and scored with approaching obstacle.

Trot – at least 35 ft and scored with approaching obstacle.

Lope - at least 50 ft and scored with approaching obstacle and be lead specific.

2. Care must be exercised to avoid setting up of any obstacles that may be hazardous to the horse or rider.
3. No extra verbal instructions may be given to the exhibitors by management or a judge that is not written in course description.
4. Judges must walk the course. Judges may remove or change any obstacle they deem unsafe, non-negotiable, or unnecessarily difficult. If any time a trail obstacle becomes unsafe during a class, it shall be repaired or removed from the course. If it cannot be repaired and horses have completed the course, the score for that obstacle shall be deducted from all previous works for that class.

5. The actual trail course cannot be made available to exhibitors or posted prior to the day of competition, but must be posted at least one hour prior to competition.
6. The course may be walked on foot by the exhibitor but no horse/rider exhibitors are allowed on the actual course after it has been set until their trail run begins.

### **Trail Class Obstacle Requirements**

1. Course must be designed using the mandatory obstacles and maneuvers plus optional obstacles. Combining of two or more of any obstacles is acceptable.
2. Prohibited obstacles: Tarps, water obstacles with slick bottoms, PVC pipe used as a jump or walk over, tires, rocking or moving bridges, logs or poles elevated in a manner that permits such to roll in a dangerous manner. Animals (live or stuffed) should only be used which would normally be encountered in a ranch setting and which are not used in an attempt to "spook" a horse.
3. Mandatory obstacles or maneuvers:
  - a. Ride over obstacles on the ground – usually logs or poles. It is recommended that all three gaits (walk, trot, lope) be used, however only two gaits are required.
  - b. Walk-Overs – Walk over no more than five logs or poles. The space between logs for walk-overs should be 20 – 24" apart and no more than 10" high. These can also be in a straight line, curved, zigzagged or raised.
  - c. Trot-Overs – Trot over no more than five logs or poles. The space between trot-overs should be 36-42". Poles may be elevated a maximum of 10". These can also be in a straight line, curved, zigzagged or raised.
  - d. Lope-Overs – Lope over no more than five poles. The space between lope-overs should be 6' to 7'. Poles may be elevated a maximum of 10". These can also be in a straight line, curved, zigzagged or raised.
  - e. Opening, passing through, and closing gate. A gate should be used that will not endanger horse or rider and requires minimum side passing.
  - f. Ride over wooden bridge. (Suggested minimum width shall be 36" wide and at least six feet long). Bridge should be sturdy, safe and negotiated at a walk only. Heavy plywood lying flat on the ground is an acceptable simulation of a bridge.
  - g. Backing obstacles – Backing obstacles are to be spaced a minimum of 28" spacing. If elevated, 30" spacing is required. Back through and around at least three markers. Back through L, V, U, straight or similar shaped course. May be elevated no more than 24".
  - h. Side pass obstacle – Any object which is safe and of any length may be used to demonstrate responsiveness of the horse to leg signals. Raised side pass obstacles should not exceed 12".
  - i. Optional obstacles: Following is a list of optional obstacles from which selections can be made, but not limited to:

- a. Jump - An obstacle whose center height is not less than 14" high or more than 24" high. Holding the saddle horn is permissible for this obstacle
- b. Carry object from one part of the arena to another,
- c. Remove and replace materials from mailbox,
- d. Trot through cones – spacing to be minimum of 6',
- e. Cross Natural ditches or up embankments,
- f. Step in and out of obstacle,
- g. Put on slicker or coat,
- h. Pick-up feet,
- i. Walk through brush,
- j. Ground Tie,
- k. Lead at the trot.

Horse should receive credit for showing attentiveness to obstacles and capability of picking their own way through the course when the obstacles warrant it, and willingly responding to the rider's cues on more difficult obstacles. Quality of movement and cadence should be considered part of the maneuver score for the obstacle.

### Trail Deductions:

- 1. Artificial appearance and/or unnecessary delay while approaching or going through obstacles.
- 2. Each tick of an obstacle.
- 3. Break of gait at walk or jog.
- 4. Placing both front or hind feet in a single-strided slot or space.
- 5. Skipping over or failing to step into a required space.
- 6. Split pole in lope-over.
- 7. Stepping on a log, pole, cone or obstacle.
- 8. Wrong lead or breaking gait at lope.
- 9. Stepping outside the confines of; falling off or out of an obstacle such as a back thru, bridge, side pass, box, or water box.
- 10. Refusals, balk, or attempting to evade an obstacle by shying or backing.
- 11. Blatant disobedience (kicking out, bucking, rearing, striking).
- 12. Failure to ever demonstrate correct lead or gait, if designated.
- 13. Failure to complete obstacle.

### Scoring Stock Horse Trail

The rider has the option of eliminating any obstacle and taking a score of "0" for the missed obstacle. A judge may ask a horse to pass on an obstacle after three refusals or for safety concerns. Each obstacle will be score from 1-10.

### Trail Credits:

Credit is given to horses negotiating the obstacles with style and some degree of speed, providing correctness is not sacrificed.

### Stock Horse Reining Class

This class measures the ability of the stock horse to perform many basic handling maneuvers. The horse should guide willingly without undue resistance.





## Speed Events Division

The classes offered in this division are Pole Bending, Barrel Racing and Stakes.

### Pole Bending

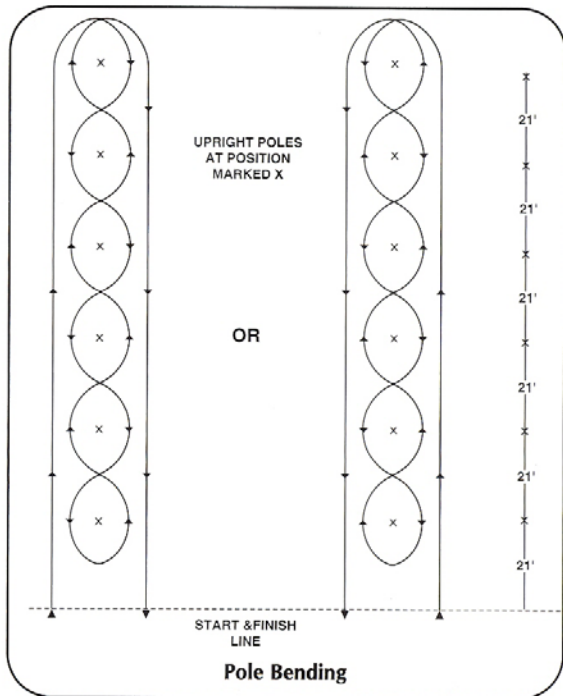

1. The pole bending pattern is to be run around six poles. The poles are to be 21 feet apart, with the first pole 21 feet from the starting line.
2. A horse may start either to the right or to the left of the first pole and then run the remainder of the pattern accordingly (see the Pole Bending diagram on page 44).
3. Failure to follow the pattern shall cause disqualification.
4. Knocking over a pole shall carry a 5 second penalty.
5. Pole bending is a timed event. Each contestant will begin from a running start. A clearly visible starting line should be provided. An electric timer should be used when possible. Otherwise, at least two watches should be used with the average time of the watches to be the official time.

6. In the event of a tie, the horse declared the winner in the runoff must run the pattern in no more than 2 seconds more than its original time, or the runoff must be held again.
7. It is recommended that all poles have at least a 14-inch base.
8. Touching a pole with hand or body is not a disqualification.

### Barrel Racing

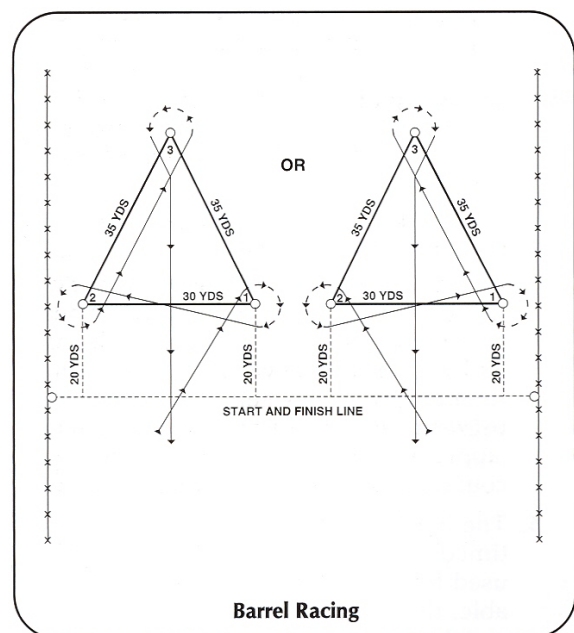

1. Failure to follow the pattern is a disqualification.
2. Knocking over a barrel shall carry a 5 second penalty.
3. The course must be measured exactly. If the pattern is too large for the available space, the pattern should be adjusted by the show officials to fit the arena. Remember to leave adequate space between the barrels and the arena fence (approximately 20 feet), and set the course to allow ample room for stopping.

4. The barrel racing contest is strictly a timed event. An electric timer should be used for official time. If one is not available, the average time of at least two watches will be the official time.
5. In the event of a tie, the horse declared the winner in the runoff must run the pattern in not more than two seconds more than its original time, or the runoff must be held again.
6. The exhibitor is allowed a running start. Timing shall begin as soon as the horse's nose reaches the starting line and will be stopped when the horse's nose passes over the finish line.
7. At a signal from the starter or timer, the exhibitor will go to barrel number 1, turning to the right around this barrel, then on to barrel number 2, this time turning to the left. At barrel number 3, the exhibitor makes the same left turn around this barrel.
8. As soon as the turn is completed around the third barrel, the exhibitor sprints the horse to the finish line.
9. This barrel course may also be run to the left. For example, the exhibitor will start to barrel number 2, turning to the left around this barrel, then to barrel number 1, turning to the right, then to barrel number 3, turning to the right, followed by the final sprint to the finish line. (See barrel racing contest pattern.)
10. An exhibitor touching a barrel with hand or body is not a disqualification.

### Stakes Race

1. This is a timed event, run with the gate closed.
2. Two poles are set 80 feet apart at opposite ends of the course. Two markers designate the start-finish line 20 feet apart mid-way between the two end poles.

3. The exhibitor starts between the two center markers and runs around the two end poles. The contestant must make a left and a right turn or a right and a left turn.
4. The exhibitor must start and finish between the center markers. Failing to do so is a disqualification. An exhibitor may touch the end pole(s) with his or her hand in the stakes race. Knocking over any of the poles or markers is a disqualification. **At the State Show, exhibitors will ride to a closed gate.**

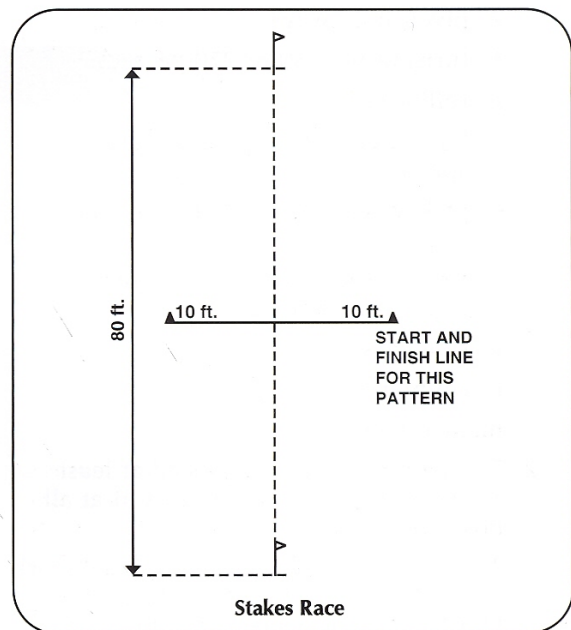

### Hunter-Flat Division

The classes offered in this division are Hunter Showmanship, Hunter Under Saddle and Hunt Seat Equitation. A 4-H'er must show in at least one of these three classes at the District show in order to be qualified to enter all three of these classes at the State Show.

### Hunter Showmanship

1. Hunter Showmanship is a performance class. The horse is considered only as a means of displaying showmanship skills.

Conformation is not judged, but condition and appearance are considered.

2. Personal attire is described in the section "Hunter Attire and Equipment".
3. Horses are to be shown in an acceptable hunter bridle or plain leather halter. No crops or bats are permitted.
4. The method of showing generally will be as described previously in Showmanship at Halter, with horses being shown according to breed-type standards.
5. Class routine may vary according to arena size and number of exhibitors.

### **Hunter Under Saddle**

1. Riders are encouraged to display their number on both sides of their saddle.
2. The class will be judged on the horse's functional correctness, way of going, manners, and condition.
3. Hunters under saddle should be suitable to purpose. They should move in a long, low frame and be able to lengthen their stride and cover ground, as in traversing hunt country following hounds. They should be obedient, alert, and responsive to their riders. Quick, short strides should be penalized. Horses that move in an artificial frame and are overflexed and behind the bit should be penalized. Judges should emphasize free movement and manners.
4. Horses enter the ring at a trot and are shown at a walk, trot, and canter while light contact is maintained with the horse's mouth.
5. Horses must work both ways of the ring at all gaits to demonstrate their ability with different leads, gaits, and transitions. Horses may change gaits

at the flat-footed walk or the trot at the judge's discretion.

6. The judge may ask finalists to hand gallop but never more than eight horses to gallop at one time.
7. Horses should back easily and stand quietly. The judge may ask that only the finalists be backed.
8. Large numbers in the class will necessitate qualification heats to accommodate all horses. After each heat, all horses should be brought to the center of the arena and the finalists identified.
9. Any portion of a class or heat may be placed on the rail for extra work by the judge at any time.
10. Horses with a low head carriage and/or head set behind the vertical and/or a sullen, lethargic, emaciated, drawn or tired look will be penalized.

### **Hunt Seat Equitation**

#### **General**

1. Riders are encouraged to display their number on both sides of their saddle.
2. Riders will be judged on their basic position in saddle, which includes position and use of hands, seat, feet, and legs, as well as the ability to control and show the horse.
3. Scores on individual works will be based on the rider's skills and execution of the pattern.
4. Riders will not be required to jump.

#### **Position**

1. General appearance. The rider should have a workman-like appearance, with a light and supple seat. Hands should convey the

impression of complete control should any emergency arise.

2. Hands. The hands should be over and in front of the horse's withers, the knuckles 30 degrees inside the vertical, with the hands making a straight line from horse's mouth to rider's elbow. The hands should not be held tightly together. The method of holding the reins is optional, and the bite of the reins may fall on either side, but it is more acceptable for the bite of the reins to lie on the off side. However, all reins must be picked up at the same time. The rider should maintain light contact with the horse's mouth at all times, except when standing still.
3. Reins. The rein of the snaffle bridle may be held either outside the little finger or between the third and little finger. The snaffle rein of the pelham or full bridle should be held outside the little finger and a curb rein between the third and little finger or between the second and third fingers. In either case, the reins should be picked up at the buckles by the right hand, then straightened and separated in the correct order by the fingers of the left hand, pulled taut, and adjusted to even pressure in both hands.
4. Basic position. The eyes should be up and the shoulders back. The toes should be out at an angle best suited to the rider's conformation; the ankles fixed in; the heels down; the calf of the leg in contact with the horse and slightly behind the girth. The iron may be either under the toe or the ball of the foot or slightly behind the ball of the foot.

### **Position in motion**

At the walk and slow trot, the body should be vertical; at the posting trot, inclined forward; at the canter, halfway between the positions for the posting trot and walk; when

galloping, inclined forward the same as for the posting trot.

### **Class Routine**

1. Each rider will individually perform a designated pattern composed from the optional list of maneuvers below. The judge will score each rider on his or her execution of the pattern as influenced by riding skills. Failure to execute or complete the pattern will not be a disqualification but shall be scored accordingly. The pattern must include only maneuvers from the following list:
  - a. Execute a slow sitting trot, posting trot, and/or extended trot.
  - b. Back.
  - c. Walk from a gallop with the emphasis on hands.
  - d. Halt from a canter.
  - e. Figure eight at the trot demonstrating the proper change of diagonals. The rider should be on the left diagonal when trotting in a clockwise direction and on the right diagonal when circling counter-clockwise. On the left diagonal, the rider will sit in the saddle when the horse's left front leg is on the ground. On the right diagonal, the rider sits in the saddle when the horse's right front leg is on the ground.
  - f. Figure eight at canter demonstrating a simple change of leads. (A simple change of leads is one in which the horse is brought back into a walk or trot before being restarted in a canter on the opposite lead.) Begin figures at the center of the two circles, so that one change of lead is shown.
  - g. Ride without stirrups.
  - h. Maintain a counter-canter.
  - i. Demonstrate a half turn on forehand and/or half turn on haunches.
  - j. Simple change of leads on straightaway.

2. The pattern should be posted at least 1 hour before the class begins, if possible.
3. The judge will use the individual work scores to determine the top riders who will be asked to work individually or on the rail. Selected riders (or all riders if the class is small) will be required to work on the rail to determine final placing.
4. Rail work will include walk, trot, and canter in one or both directions of the ring at the discretion of the judge. A reverse should be executed by turning away from the rail.
5. The riders may be requested to gallop in safe groups and/or perform additional tests.
4. Horses being considered for an award will be brought back on the rail and shown at a walk, trot, and canter both directions of the ring.
5. After the second fence, riders may be instructed to hand gallop and/or halt and back up.
6. Finalists may be asked to hand gallop, but never more than a safe number will be asked to gallop at one time.
7. Horses should back easily and stand quietly.
8. Ticks and jumping faults will be scored, as in the Working Hunter Class, at the discretion of the judge.
9. Placing for the class shall be determined by allowing a minimum of 70 percent for fence work and a maximum of 30 percent for work on the rail.

## **Open Division**

### **Hunter Over Fences Division**

The classes offered in this division are Working Hunter, Hunt Seat Equitation Over Fences, Hunter Hack and Open Jumping.

At the State 4-H Horse Show there will be a warm-up for the over fences classes. The number of horses allowed in the arena at a time will be determined by the number of entries in the show.

### **Hunter Hack**

1. Riders are encouraged to display their number on both sides of their saddle.
2. Horses will be judged on way of going, manners, even hunting pace, and jumping style.
3. To begin the class, all horses will be required to complete two jumps, each a **minimum of 2 feet** and maximum of 2 feet 9 inches in height. Jumps must be set at multiples of 12 feet apart at 36, 48 or 60 feet.

### **Working Hunter**

1. Riders are encouraged to display their number on both sides of their saddle.
2. Horses will be judged on performance, manners, hunting pace, style of jumping and way of moving, as well as suitability for actual use in the hunting field.
3. All horses must be serviceably sound. Exhibitors shall trot a soundness circle on a loose rein, immediately following completion of the course. Any horse showing lameness, broken wind or impairment of vision shall be refused an award at the judge's discretion.
4. Each horse individually will negotiate a course of at least eight jumps with a minimum of four obstacles. At least one change of direction is required. The course should be posted 1 hour before the class. Judging will start when the horse enters the arena and will end when the horse leaves the arena.

5. Minimum height of fences will be 2 feet 9 inches; maximum height will be 3 feet 6 inches.
6. Management should provide at least one practice jump. This jump should be in a warm-up area or arena.
7. Jumps to be used may be selected from the following list but will not be limited to this list:
  - a. Brush.
  - b. Post and rail.
  - c. Gate.
  - d. Chicken coop.
  - e. Stone wall.
  - f. In and out: post and rails spaced 24 to 36 feet apart. (This should never be used as the first obstacle in the course.)
8. When designing a hunt course, space the jumps a minimum of 48 feet apart, with all intervals in multiples of 12 feet. The distance of take off or landing from the jump usually ranges from a distance equal to the height of the jump to one-and-one-half times the height of the jump (for example, for a 3-foot fence, the take off point would be from 3 to 4 ½ feet from the fence).
9. Faults:
  - a. An even hunting pace is required for a good performance. Excessive speed, breaking gaits, wrong leads, etc., will be penalized.
  - b. Jumping form and style will be considered. Unsafe jumping will be penalized regardless of whether or not the jump was cleared.
  - c. Light touches are not to be considered in the jumping, but may be recorded for reference in extremely close competition. Touching brush only on a brush jump is not to be scored as a touch.
- d. When a horse makes two faults at an obstacle, only the major fault on the top element will be scored. Refusals are cumulative and count in addition.
- e. When an obstacle contains more than one jump, horses are scored on each jump.
- f. In case of refusal or runout on an obstacle that contains more than one jump, the contestant must rejump the previous as well as the remaining jumps.
- g. Three cumulative disobediences, a fall of horse and/or rider, or going off course disqualifies the entry. Dismissed contestants will exit promptly.
10. The following point system may be used in scoring working hunter.
  - a. Knock-downs.
    - With any part of the horse's body behind the stifle: 4 faults.
    - With any part of the horse's body in front of the stifle: 8 faults.
    - Of standard or wing in jumping obstacles with any part of the horse, rider, or equipment: 8 faults.
    - A horse's touching an obstacle, causing a rail of an adjoining panel or wing to fall, shall not be construed as a knock-down.
  - b. Disobediences.
    - Circling once upon entering the ring and once upon leaving is permissible.

- First refusal, runout, bolting on course, extra circle, or showing an obstacle to a horse: 8 faults.
  - Second refusal, runout, bolting on course, extra circle, or showing an obstacle to a horse: 8 faults.
  - Third refusal, runout, bolting on course, extra circle, or showing an obstacle to a horse: Elimination.
  - Jumping an obstacle before the reset: Elimination.
  - Bolting from the ring: Elimination.
  - Failure to keep proper course: Elimination.
  - Jumping an obstacle not included in course: Elimination.
- c. Scoring shall be on a basis of 0-100 with an approximate breakdown as follows:
- 90-100: an excellent performer and good mover that jumps the entire course with cadence, balance and style.
  - 80-89: a good performer that jumps all fences reasonably well; and an excellent performer that commits one or two minor faults.
  - 70-79: the average, fair mover that makes no serious faults, but lacks the style, cadence and good balance of the scoper horses; the good performer that makes a few minor faults.
  - 60-69: poor movers that make minor mistakes; fair or average movers that have one or two poor fences but no major faults or disobediences.
  - 50-59: a horse that commits one major fault, such as a hind knockdown, refusal, trot, cross canter or drops a leg.
  - 30-49: a horse that commits two or more major faults, including front knockdowns and refusals, or jumps in a manner that otherwise endangers the horse and/or rider.
  - 10-29: a horse that avoids elimination but jumps in such an unsafe and dangerous manner as to preclude a higher score.
11. In working hunter classes, all horses work one go-round.

## **Open Jumping**

1. Riders are encouraged to display their number on both sides of their saddle.
2. Jumpers are scored and placed on a mathematical basis and penalty faults, which include disobedience, falls, and knock-downs. Time may be used to break ties in the second round.
3. Each horse individually will negotiate a course consisting of at least four different obstacles and make a minimum of eight jumps. Refer to Working Hunter Rule 7 for types of jumps.
4. Both a starting line (at least 12 feet in front of the first obstacle) and a finish line (at least 24 feet beyond the last obstacle) must be indicated by markers (at least 12 feet apart) at each end of the lines.
5. The height of all fences will be a maximum of 3 feet 6 inches (42 inches) in the first elimination round.

6. At least 50 percent of the jumps must be raised no less than 3 inches and no more than 6 inches for the second round. The first jump in each round should be no more than the minimum height used in the elimination round.
7. Horses with a clean first round will jump a second round with the course shortened and the round timed.
8. Jumpers will be scored as follows: when a horse commits two or more faults at the same obstacle, only the major fault, or only one in case of equal faults, will count except when a disobedience occurs. Disobediences are cumulative and faulted in addition to other faults occurring at the same obstacle.
  - a. Knock-down: When a horse attempts to jump an obstacle and knocks down the obstacle or any portion of it, the standard, or the wing with any portion of the horse, rider, or equipment, it is considered a knock-down and counts four faults, with the following exception, when a horse causes a knock-down while refusing, it is not to be faulted for a knock-down, but should be given only the correct amount of faults for the refusal.
  - b. Disobediences:
    - **Refusals.** When a horse stops in front of an obstacle (whether or not the obstacle is knocked down or altered), it is a refusal, unless the horse then immediately jumps the obstacle without backing one step. If the horse takes even one step backwards, it is a refusal.

If the horse is moved toward an obstacle after a refusal without attempting to jump, it is considered another refusal.

In the case of a refusal on an in-and-out jump, the horse must return to the start of the in-and-out sequence and rejump the previous as well as the following elements.

- **Runout.** A runout occurs when a horse evades or passes the obstacle to be jumped; jumps an obstacle outside its limiting markers; or the horse or rider knocks down a flag, standard, wing, or other object limiting the obstacle (without jumping the obstacle).
- **Loss of forward movement.** Failure to maintain a trot, canter, or gallop after crossing the starting line (except when it is a refusal, a runout, or due to uncontrollable circumstances, such as when an obstacle is being reset) is a disobedience.
- **Unnecessary circling on course.** Circling once upon entering the ring (prior to crossing the starting line) and once upon leaving is permissible. Any additional circling on the course or unnecessary showing of a fence to the horse is a disobedience.
  - First disobedience (anywhere on course): 3 faults.
  - Second disobedience (anywhere on course): 6 additional faults.
  - Third disobedience (anywhere on course): Elimination

- c. Fall of horse and/or rider:  
Elimination.
- d. Failure to complete course,  
off course: Elimination.
- e. Jumping an obstacle before it  
is reset or without waiting for  
the signal to proceed:  
Elimination.
- f. Starting before the judge's  
audible signal to proceed;  
jumping an obstacle before  
the start or after crossing the  
finish line, whether forming  
part of course or not; jumping  
obstacles out of order; off  
course: Elimination.
- g. Failure to enter ring within 1  
minute of being called:  
Elimination.
- h. Failure to cross the starting  
line within 1 minute after the  
judge's audible signal to  
proceed: Elimination.
- i. Jumping any obstacle before  
crossing the starting line  
unless the obstacle is  
designated as a practice  
jump: Elimination.
- j. In cases of broken equipment,  
the rider either may continue  
without penalty or be  
eliminated. If a shoe is lost,  
the rider may continue without  
penalty or be eliminated.

### **Hunt Seat Equitation Over Fences**

1. Riders are encouraged to display  
their number on both sides of their  
saddle.
2. The rider's performance and skills  
over fences are being judged in  
this class: the rider's basic

position in the saddle; the position  
and use of hands, legs and feet;  
the ability to control and show the  
horse.

3. Each rider shall perform a pattern  
consisting of at least six jumps.  
Three cumulative refusals will  
cause elimination. Maximum  
fence heights and types of fences  
shall be like those listed in  
Working Hunter rules.
4. Position: Same as Hunt Seat  
Equitation.
5. The judge will score each rider on  
his or her individual skills and  
execution of the pattern.
6. The top riders may be required to  
work on the rail to determine the  
final placings.

### **Roping Division**

#### **General Rules**

1. All roping events will be timed. **All runs must be completed with in 30 seconds.**
2. Equipment: See Timed Event  
Class Equipment. ***Long-sleeved shirts are required.***
3. All roping events at the State  
Show will be conducted with the  
"back gate" open.
4. One official will be designated as  
barrier judge and one official will  
be designated as official flagman.
5. All exhibitors must start from  
behind an automatic barrier.  
Breaking the barrier will result in a  
10-second penalty added to the  
contestant's time. Length of score  
will be determined by arena  
conditions.

6. Any unruly horse or horse considered unsafe to either the contestant or the arena help may be dismissed from the competition. Horses are expected to be able to enter the box and wait for the barrier to be set. Decisions on such matters are made by show management personnel in charge of the roping events and are not subject to protest.
7. All claims of "foul" by barrier or gateman must be declared prior to contesting the cattle.
8. All cattle must be roped before they exit the arena.
9. All decisions of the officials are final and not subject to protest.
10. **All horses and contestants must be eligible according to the Texas State 4-H Horse Show rules.**
11. Final placings are determined from cumulative times.

### **Tie-Down Calf Roping**

1. All exhibitors in this event must use a neck-rope. Use of keepers and jerk lines is optional.
2. Exhibitors may throw two loops, provided the second rope is carried. Exhibitors may not recoil the rope for a second loop.
3. If the calf is down when the exhibitor reaches it, the calf must be gotten up prior to flanking and/or legging. If the roper's hand is on the calf when the calf falls, the calf is considered thrown by hand. (Note: Judge's ruling on these circumstances is not subject to protest).

4. The rope must **hold calf until roper gets their hands on the calf.**
5. For a tie to be legal, the string must go around three legs at least one time and a half hitch.
6. The calf must stay tied for 6 seconds after the roper remounts and puts slack in the rope.
7. Only the roper may touch the calf. Any assistance will be a disqualification. Youth too small to throw and tie the calves should not enter this event.
8. Based on the rules above, the officials shall have the authority to make judgments regarding any situation that might result in injury to contestants or livestock.

### **Breakaway Roping**

#### **General Rules**

See general rules 1 to 11 above.

1. At the State Show, only one loop will be allowed.
2. A regular rope is tied to the saddle horn or swell with a breakable string. Time starts at the signal of the barrier flag and stops when the flagman signals that the rope breaks away from the saddle as a result of a legal catch.
3. Any unruly horse or horse considered unsafe to either the contestant or the arena help may be dismissed from the competition. Horses are expected to be able to enter the box and wait for the barrier to be set. Decisions on such matters are made by show management personnel in charge of the roping events and are not subject to protest.

4. The only legal catch is a clean bell collar loop that causes the string to break away from the saddle horn. A bell collar catch is defined as the looping passing over the head of the calf, ahead of the tail and no feet or legs in the loop.
5. Judges will rule whether a catch is legal and whether the rope breaks away as a result of a legal catch, or as a result of the horse or calf stepping on the rope or similar occurrence. The exhibitor will be given a “no time” when something other than a legal catch causes the rope to break away.
6. A piece of cloth should be attached to the tail of the rope to signal when the rope breaks.

## **Team Roping**

### **General Rules**

See general rules 1 to 11 above.

1. This will be timed event. Time starts with the release of the barrier and ends when the ropes are tight and the horses have faced each other.
2. Legal head catches are both horns, half-head, and around the neck. A 5-second penalty will be assessed for roping only one hind foot.
3. Contestants have the option of dallying or tying on their ropes.
4. Any unruly horse or horse considered unsafe to either the contestant or the arena help may be dismissed from the competition. Horses are expected to be able to enter the box and

wait for the barrier to be set. Decisions on such matters are made by show management personnel in charge of the roping events and are not subject to protest.

5. A maximum of two loops is allowed for each team. Failure to complete requirements for time within this limit will result in no time. The run must be completed in **30** seconds. At the State Show, the back gate will be opened, and cattle must be roped before they exit the arena.
6. Riders must remain mounted. Loss of the rope by either header or heeler is an automatic disqualification.
7. A 4-H'er enters as an individual and may enter only once. The partner can be any 4-H'er who also is entered in the Team Roping. A 4-H'er may help as many times as desired. Points will be awarded only to the person entered, not the helper.
8. Each roper in the class must meet eligibility requirements and also must be entered in the class.

## **Stock Horse Division**

The classes in this Division are Team Penning, Working Cow Horse, Cutting, Reining and Stock Horse Trail.

### **Team Penning**

The Team Penning in the 4-H Horse Program might more appropriately be called Team Cattle Handling, because the rules have been designed to promote handling, sorting and moving cattle. This is the rationale for the location of both the time line and the catch pen, since both differ somewhat from other association rules.

1. Penning is a team event. Each team shall consist of three riders. **Contestants are limited to entering and participating on one team.** Each team will have one full go. Teams receiving a time for three head penned in the first go will automatically progress to the second go **at State**. If less than 10 teams pen three head in the first go, then teams penning two head, then one head will be included (based on time) in order to advance 10 teams to the second go. After the second go, cumulative times from both goes will determine the top 10 teams returning to the finals **at State**. **All riders on a team must come from the same Extension district.** Entries will list the name of each team member; if all contestants' names are not listed on the entry form, the entry will not be accepted. Any substitutions at the show will be subject to \$50.00 fee (see rule 4, page 13).
2. Teams will be given their assigned cattle numbers at the time line. Team members(s) must cross the time line within 30 seconds after the cattle numbers are called. Each team will receive a warning after 20 seconds.
3. The starting line will be drawn across the arena 40 feet in front of the settled herd or adjusted 5 feet at a time to fit the arena.
4. The pen shall be on the opposite end of the arena from the cattle. The open end of the pen shall be 30 feet from the arena fence or adjusted 5 feet at a time to fit the arena. The pen shall be no greater than 12 feet by 24 feet, with a 12-foot opening and a 12-foot wing with a slight angle toward the opening of the pen. (See Team Penning figure.)
5. At District shows, the start/foul line will be drawn across the arena at least 40 feet in front of the settled herd. It shall be increased by 5 feet for every 10 feet that an arena exceeds 90 feet in width. Example: A pen is 120 feet wide, so the foul line will be placed 40 feet plus 15 additional feet for a total of 55 feet. This is based on the arena use for Team Penning at the State Show; it is 210 feet long and 90 feet wide.
6. Time will begin when the first rider crosses the time line. Any or all team members may cross the time line. Any or all team members may cut. The team has 3 minutes to cut three head bearing the team's designated numbers, move them across the time line, and pen them. Time ends when a team captain signals the time keeper. One member must be in the entrance of the pen when time is called.
7. The fall of a horse or rider being judged shall be cause for disqualification in all classes. A horse is considered having fallen when he or she is on their side and all four feet are extended in the same direction. Rider is considered to have fallen when he or she is not astride.
8. If more than one head, other than the assigned numbers, are brought across the time line, the team will be disqualified. Once a team has successfully cut one, two, or three head of assigned cattle from the herd and has committed itself to working on the pen end of the arena, holding the herd at the opposite end is no longer required. Cattle that then cross the line on their own, without being caused to do so by the team member(s) are not counted.

9. If an animal not bearing the team's designated number is penned, the team will be disqualified. Any teams attempting to cut or drive cattle using hats, ropes, quirts, reins, or any other equipment will be disqualified.

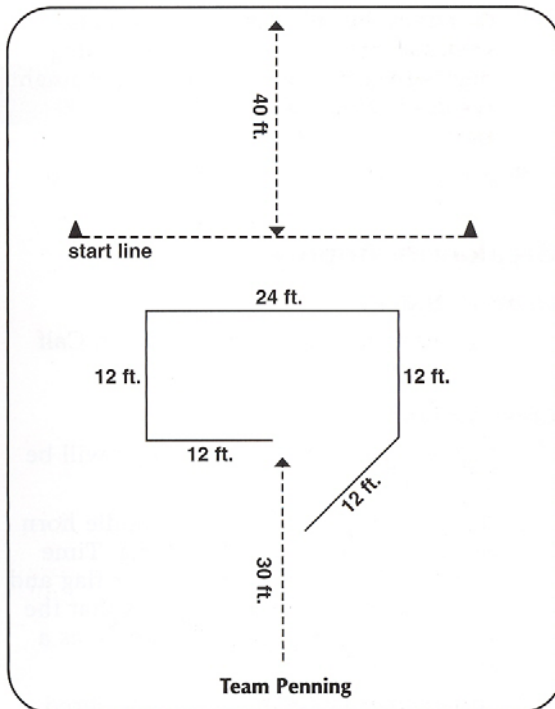

10. A team may call for time with only one or two assigned cattle penned. However, teams penning three head place higher than penning two or one, regardless of the time. In a multiple go-round contest, in the event that teams pen their cattle in only one go-round, the fastest time wins, regardless of which go-round. In a multiple go-round contest, the teams that pen in each go-round will beat teams that fail to pen in a go-round, regardless of the number of cattle penned or time. Teams will receive a 30-second warning prior to the 3-minute time limit.
11. If contestants are unable to see their cattle numbers because of circumstances beyond their control, the members may request a new number assignment at any

time during their team's 3-minute period. The awarding of a new number will be left to the discretion of the flagman. If a new number should be awarded, the team will run next in the working order. If a team should not be awarded a new number, they will receive a "no time."

12. All exhibitors and horses must be eligible according to Texas State 4-H Horse Show Rules.
13. Attire and Equipment. See Timed Event Classes attire and equipment (page 16).
14. At the discretion of the class superintendent, flagman, or judge, teams who are carelessly scattering the herd, abusing, or intentionally mistreating the cattle will be excused from the arena and will receive a "no time".

## Working Cow Horse

- Both the cattle-work part of this event and the reining part are mandatory. Emphasis on cow-work scoring portion shall be based on the horse's maintaining control of the cow at all times, exhibiting superior cow sense, and natural cow-working ability without excessive reining or spurring. Failure of an exhibitor to attempt to complete the cow-work portion of the class, as well as the reined work, will result in the exhibitor being disqualified.
- Exhibitors are being judged when they enter the arena. Scoring will be on the basis of 0-100, with 70 denoting an average performance. The same basis of scoring shall apply to both the reined work and the cow-work. In the event of a tie, the entry with the highest cow-work will be declared the winner.

3. Fall of the horse and/or rider while being shown in cow-work shall eliminate the entry.

### Miscellaneous

Cattle work may be done immediately following each individual's pattern work or immediately after the completion of pattern work by all horses being exhibited (at the discretion of the judge).

### Prescribed Cow-Work

4. At the start of the cow-work portion, each contestant, upon receiving a cow in the arena, shall hold the cow on the prescribed end of the arena for a sufficient time. This demonstrates the ability of the horse to contain the cow on that end. After a reasonable amount of time, the contestant shall take the cow down the fence, making at least one turn each way on the fence. Then the contestant shall take the animal to an open part of the arena and take the animal in a circle at least once in each direction. This is an ideal fence work; however, the judge should take into consideration the size of the arena, the condition of the ground, and the disposition of the cattle.

5a. ***(Note: If a contestant pulls up and raises a hand requesting another cow, it is the judge's option to award a new cow. If request is denied, exhibitor should immediately resume work or retire from the pen.)***

- 5b. If time and the number of cattle permit, the judge, at his or her discretion, may award new cattle because:

- The cow will not or cannot run.

- The cow will not leave the end of the arena.
- The cow is blind or will not yield to the horse.
- The cow leaves the arena

This is to enable the contestant to show his or her horse's ability on the cow.

6. The following characteristics are considered as faults:
  - a. Exaggerated opening of mouth.
  - b. Hard or heavy mouth.
  - c. Nervous throwing of head.
  - d. Lugging on bridle.
  - e. Halting or hesitation while being shown, particularly when being run out, indicating anticipation of being set up, which is characteristic of an overtrained horse.
  - f. Losing a cow or being unable to finish a pattern because of a bad cow; the contestant shall be penalized at the judge's discretion.
  - g. Touching the horse or saddle with the free hand, except during the cow-work portion of the class when the rider may hold onto the horn.
  - h. A contestant's horse that turns tail on the cow shall receive a zero. Two hands on the reins or more than one finger between the reins shall constitute a zero.

7. The characteristics of a good working cow horse are:
  - a. Good manners.
  - b. Shifty, smooth movements with the horse's feet under him at all times; when stopping, hind feet should be well under him.
  - c. A soft mouth that responds to a light rein, especially when turning.
  - d. Head maintained in its natural position.
  - e. Able to work at reasonable speed and still be under the control of the rider.
8. Specific penalties are as follows:
  - a. 5-point penalties
    1. Not getting one turn each way (5 points each way).
    2. Deliberate spurring or use of the romal forward of the cinch.
  - b. 3-point penalties
    1. Biting or striking the cow.
    2. Hanging up on the fence (refusing to turn).
    3. Exhausting or overworking the cow before circling.
    4. Knocking down the cow without having a working advantage.
  - c. 2-point penalty: Going past the corner of the arena before turning the cow when going down the fence.
  - d. 1-point penalties
    1. Loss of working advantage.
    2. Horses that run past the cow shall be penalized 1 point for every horse's length past the cow. When the horse's buttocks pass the cow's head by one horse's length, it is one length past.
    3. Failure to pass middle marker on first turn before turning cow.
    4. Using the corner or the end of the arena to turn the cow when going down the fence.
    5. Each time the arena is crossed to use the opposite fence to achieve a turn.
    6. Slipping a rein.
  - e. 0 score
    1. Turn tail.
    2. More than one finger between the reins.
    3. Leaving the work area before the pattern or work is complete:
      - a. Any horse that is out of control while working the cow, thus endangering the rider (such as crossing the path of the cow) shall be called off the cow.
      - b. Any horse that runs over the cow, thus causing the fall of horse and/or rider shall terminate the work at that time.

4. Use of two hands on the reins.
5. The judge may blow the whistle at any time to terminate the work.
6. A score of 0 will be charged if the work is not complete at that point.
7. Contestant should keep working until the judge blows the whistle. If the exhibitor quits working before the whistle, a score of 0 will be given in the cattle working portion.

Either of two working cow horse patterns may be used. (See patterns 1 and 2.) One of the two is to be selected by the judge of the class and used by all contestants in the class.

The approved patterns will be used, and each contestant will cause his or her horse to travel in the gait indicated for each part of the pattern.

### Working Cow Horse Pattern #1

1. Begin work to the right.
2. Figure eight; then, after the final lead change (before the point marked X) proceed to point C at a walk or trot.
3. Begin a run. (C)
4. Perform a sliding stop. (D)
5. Turn away from the rail and begin a second run. (E)
6. Perform a sliding stop. (F)
7. Turn away from the rail and make a short run. (G)
8. Perform a sliding stop. (H)
9. Back up. (I)
10. Do a 360-degree spin to the right or left. (J)
11. Do a 360-degree spin (k) in the direction opposite to that taken in step 10.
12. The bridle may be dropped at the judge's discretion.

### Dry Work

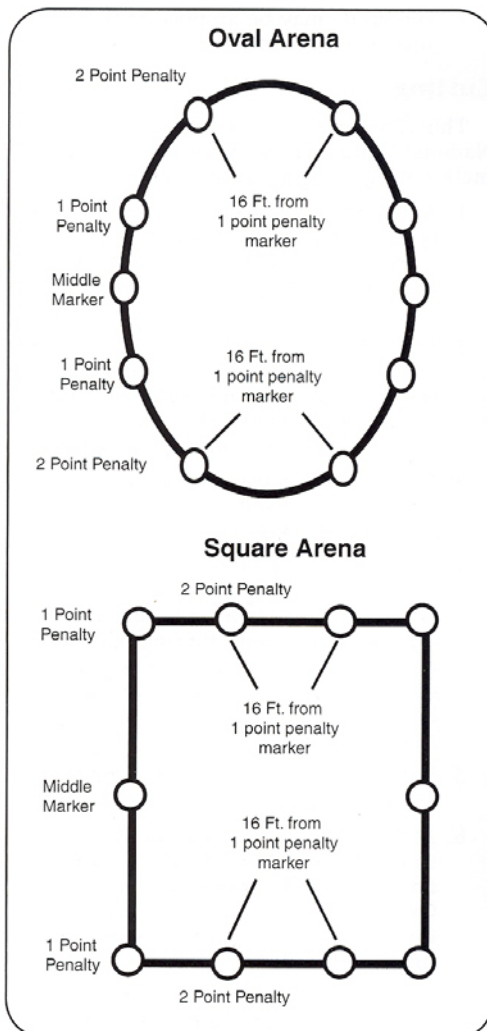

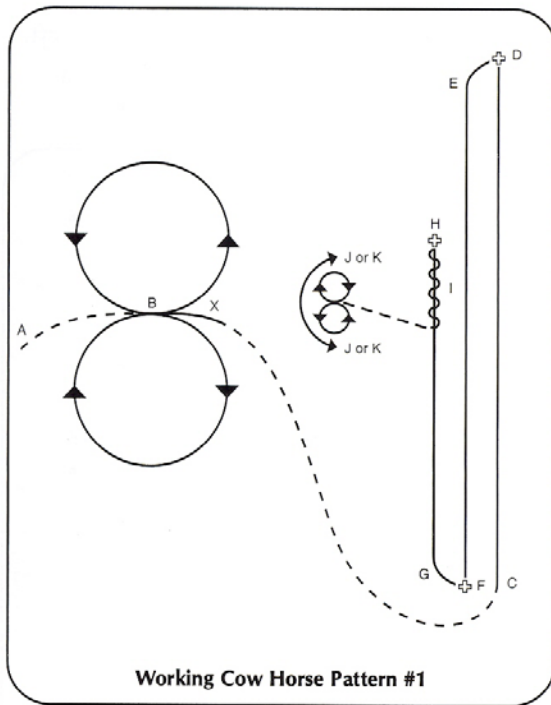

7. Run the full length of the arena to a square sliding stop and hesitate.
8. Do two and one-half spins to the left.
9. Run past the center of the arena to a square sliding stop.
10. Back to the center of the arena (minimum 10 to 15 feet).
11. Do a 360-degree spin to the right or left.
12. Do a 360-degree spin in the direction opposite to that taken in step 11.
13. The bridle may be dropped at the judge's discretion.

### Working Cow Horse Pattern #2

1. Begin at the center of the arena facing the right wall or fence. Begin on the right lead and complete a circle to the right away from the judge.
2. At the center of the arena, change leads and do two circles to the left, approximately the same size.
3. At the center of the arena, change leads.
4. Go to the end of the arena, and without stopping or breaking gait, start the run near the approximate center of the arena. Run the full length of the arena.
5. Do a square sliding stop and hesitate.
6. Do two and one-half spins to the right.

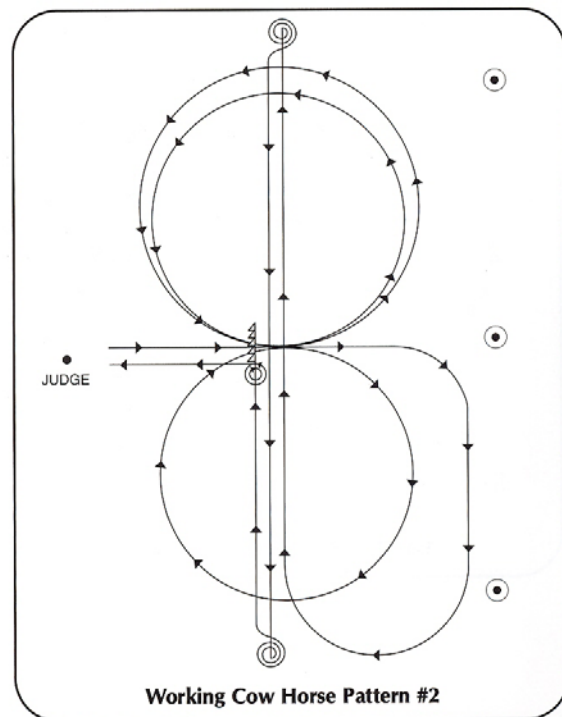

## Cutting

This class will be judged using the current National Cutting Horse Association scoring methods regarding penalties and credits.

1. A horse will be given credit for the ability to quietly enter a herd of cattle, make a deep cut, separate a cow from the herd, and set the cow up in the center of the arena.
2. Credit is given to a horse that works on a loose rein without being reined while working the cow. The degree of difficulty involved while working and eye appeal are factors considered for credit.
3. Penalties are assessed when a horse loses his working advantage and when a horse is reined or ridden on a tight rein.
4. Examples of penalties are back fence, hot quit, two hands on reins, horse quitting a cow, loosing a cow, changing cattle after a commitment, turning tail to cow being worked, and falling. The severity of these and other penalties are specified in the National Cutting Horse Association rule book.
5. Scoring ranges from 60 to 80 points, with an average performance being 70.
6. At the State Show, all contestants will show in the first go-round. Those scoring **a 121 or higher** will advance to the finals. Overall class awards will be based on the total of the preliminary score and finals score.
7. At the State Show, herd holders and turnback persons who are not exhibitors are not to ride any horse that is entered in any class at the show. It is the responsibility

of the exhibitor to arrange for herd holder and turnback help.

## Reining

1. Each contestant will individually perform the required pattern.
2. Each horse will be judged on the neatness, dispatch, ease, calmness, and speed with which it performs the pattern.
3. Excessive jawing, open mouth, or head raising on stop; lack of smooth sliding stops on haunches; breaking gaits; refusing to change lead; anticipating signals; stumbling or falling; wringing tail; backing sideways; changing hands or reins; losing the stirrup; holding on to the saddle, two hands on reins; or any unnecessary aid (such as unnecessary talking, petting, spurring, quirting, jerking of reins, etc.) given by the rider to the horse to induce the horse to perform, will be considered a fault and scored accordingly.
4. The horse should rein and handle easily, fluently, and effortlessly and with reasonable speed through the pattern.
5. Any horse not following the pattern will be disqualified.
6. Scoring will be on the basis of 0 to infinity, with 70 denoting an average performance.
7. Reining patterns 1 and 2 may be used at the State Show to determine those contestants who advance to the finals. Final placings are determined on cumulative score.

## Scoring

1. Scoring will be on the basis of 0 to infinity, with 70 denoting an

- average performance. The individual maneuvers are scored in  $\frac{1}{2}$  point increments from a low of  $-1 \frac{1}{2}$  to a high of  $+1 \frac{1}{2}$ , with a score of 0 denoting a maneuver that is correct with no degree of difficulty. Scores will be announced after each horse.
2. Any ties for the first place will be worked off, using the same pattern and order of go that was used during the event; however, there will be no more than one run-off. If the score remains tied after the run-off, the entrants will be named co-champions.
  3. The following will result in no score:
    - a. Abuse of an animal in the show arena and/or evidence that an act of abuse has occurred before or during the exhibition of a horse in competition.
    - b. Use of illegal equipment, including wire on bits or curb chains.
    - c. Use of illegal bits or curb chains.
    - d. Use of tack collars, tie downs or nose bands.
    - e. Use of whips or bats.
    - f. Use of any attachment that alters the movement of or circulation to the tail.
    - g. Failure to dismount and/or present the horse and equipment to the appropriate judge or class superintendent for inspection.
    - h. Disrespect or misconduct by the exhibitor.
  - i. The judge(s) may excuse a horse at any time while in the arena for unsafe conditions or improper exhibition pertaining to both the horse and/or rider.
  4. Excess rein may be straightened at any place a horse is allowed to be completely stopped during a pattern.
  5. The following will result in a score of 0:
    - a. Use of more than the index or first finger between reins.
    - b. Use of two hands or changing hands.
    - c. Failure to complete the pattern as written.
    - d. Performing the maneuvers other than in the specified order.
    - e. The inclusion of maneuvers not specified, including, but not limited to:
      1. Backing more than 2 strides.
      2. Turning more than 90 degrees.
      3. Exception: a complete stop in the first quarter of a circle after a lope departure is not to be considered an inclusion of maneuver; a 2-point break of gait penalty will apply.
    - f. Equipment failure that delays completion of pattern, including dropping a rein that comes in contact with the ground while the horse is in motion.

- g. Balking or refusal of command where pattern is delayed.
  - h. Running away or failing to guide where it becomes impossible to discern whether the entry is on pattern.
  - i. Jogging in excess of one half-circle or one-half the length of the arena.
  - j. Overspins of more than  $\frac{1}{4}$  turn.
  - k. Fall to the ground by horse or rider.
- e. If a horse does not completely pass the specified marker before initiating a stop position.
8. Starting or performing circles or figure eights out of lead will be judged as follows:
- a. Each time a horse is out of lead, a judge must penalize by 1 point. The penalty for being out of lead is cumulative, and the judge will add 1 penalty point for each  $\frac{1}{4}$  of the circumference of a circle or any part thereof that a horse is out of lead.
  - b. A judge is required to penalize a horse  $\frac{1}{2}$  point for a delayed change of lead by one stride.

Note: Neither a no score nor 0 is eligible to place in a go-round nor class, but a 0 may advance in a multi-go event while a no score may not.

6. The following will result in a penalty of 5 points:

- a. Spurring in front of cinch.
- b. Use of either hand to instill fear or praise.
- c. Holding the saddle with either hand.
- d. Blatant disobedience including kicking, bucking, rearing and striking.

7. The following will result in a 2 point penalty:

- a. Break of gait.
- b. Freezing up in spins or rollbacks.
- c. On walk-in patterns, failure to stop or walk before executing a lope departure.
- d. On run-in patterns, failure to be in lope before reaching the first marker.

9. Deduct  $\frac{1}{2}$  point for starting circle at a jog or exiting rollbacks at a jog up to two strides. For jogging beyond two strides but less than  $\frac{1}{2}$  circle or  $\frac{1}{2}$  length of arena, deduct 2 points.

10. Deduct  $\frac{1}{2}$  point for over or under spinning up to  $\frac{1}{8}$  of a turn; deduct 1 point for over or under spinning up to  $\frac{1}{4}$  of a turn.

11. In patterns requiring a run-around, failure to be on the correct lead when rounding the end of the arena will be penalized as follows: for  $\frac{1}{2}$  the turn or less, 1 point; for more than  $\frac{1}{2}$  turn, 2 points.

12. There will be a  $\frac{1}{2}$  point penalty for failure to remain a minimum of 20 feet from the wall or fence when approaching a stop and/or rollback.

13. The judge shall have the authority to remove any contestant from a show he or she is judging if the contestant shows any disrespect or misconduct as to render him- or herself or the show in an unprofessional manner.

- Judges shall be the sole person(s) responsibility for determining if a rider has correctly completed the pattern.

### Reining Pattern #1

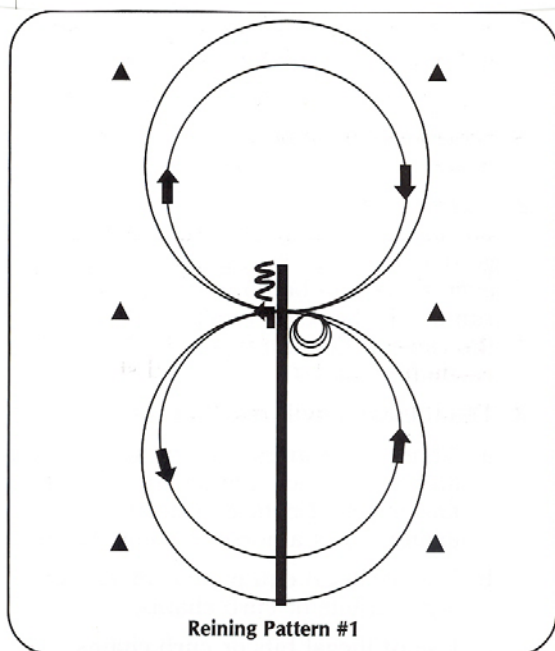

- Run down center of arena past center marker, stop and back up. Hesitate.
- Make a quarter turn to the left.
- Lope a large, fast circle to the right, followed by a small, slow circle to the right. Change leads.
- Lope a large, fast circle to the left, followed by a small, slow circle to the left.
- Stop.
- Complete four spins one direction. (Choose to spin four times to either the left or the right, your choice.)
- Pattern complete. Exit the arena.

### Reining Pattern #2

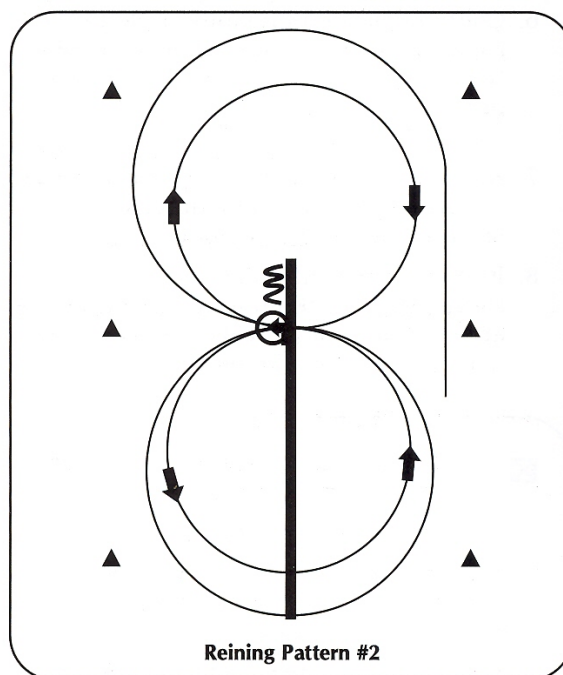

- Run down center of arena past center marker, stop and back up. Hesitate.
- Do four and one-quarter spins to the left.
- Lope a small, slow circle to the left, followed by a large, fast circle to the left. Change leads.
- Lope a small, slow circle to the right.
- Begin a large, fast circle to the right, but do not close circle.
- Run straight down the right side of the arena past center marker and stop.
- Pattern complete. Exit the arena.

## Reining Pattern #3

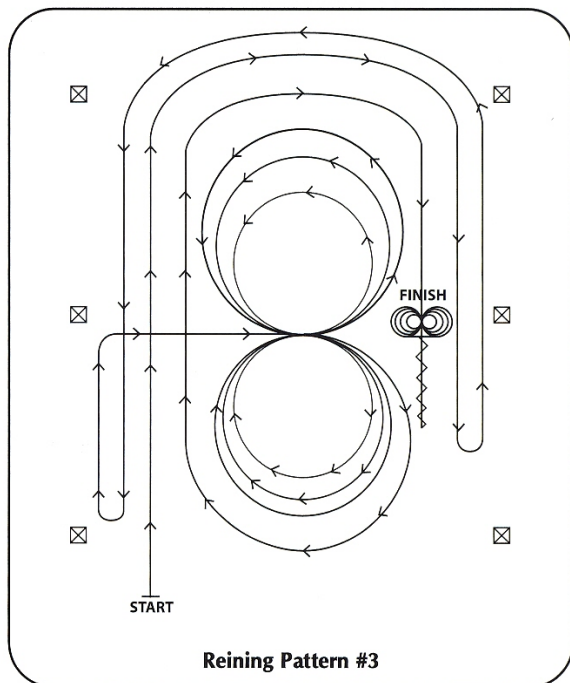

1. Beginning and staying at least 20 feet from the walls or fence, lope straight up the left side of the arena, circle the top end of the arena, run straight down the opposite or right side of the arena past the center marker, and do a left rollback – no hesitation.
2. Continue straight up the right side of the arena staying at least 20 feet from the walls or fence, circle back around the top of the arena, run straight down the left side of the arena past the center marker, and do a right rollback – no hesitation.
3. Continue up the left side of the arena to the center marker. At the center marker, the horse should be on the right lead. Guide the horse to the center of the arena on the right lead, and complete three circles to the right: the first two circles large and fast; the third circle small and slow. Change leads at the center of the arena.
4. Complete three circles to the left: the first two circles large and fast; the

third circle small and slow. Change leads in the center of the arena.

5. Begin a large, fast circle to the right but do not close this circle. Continue up the left side of the arena staying at least 20 feet from the walls or fence, circle the top of the arena, run straight down the opposite or right side of the arena past the center marker, and do a sliding stop. Back up at least 10 feet. Hesitate.
6. Complete four spins to the right.
7. Complete four spins to the left. Hesitate to demonstrate completion of the pattern.

## Reining Pattern #4

Beginning at the center of the arena facing the left wall or fence.

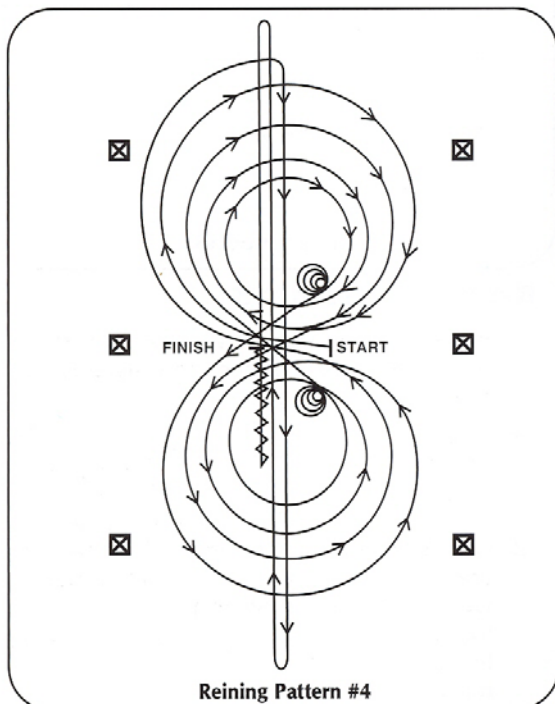

1. Beginning on the right lead, complete three circles to the right: the first two circles large and fast; the third circle small and slow. Stop at the center of the arena.
2. Complete four spins to the right. Hesitate.
3. Beginning on the left lead, complete three circles to the left: the first two circles large and fast; the third circle small and slow. Stop at the center of the arena.
4. Complete four spins to the left. Hesitate.
5. Beginning on the right lead, run a large fast circle to the right, change leads at the center of the arena, run a large fast circle to the left, and change leads at the center of the arena.
6. Continue around previous circle to the right. At the top of the circle, run down the middle to the far end of the

arena past the end marker and do a right rollback – no hesitation.

7. Run up the middle to the opposite end of the arena past the end marker and do a left rollback – no hesitation.
8. Run past the center marker and do a sliding stop. Back up to the center of the arena or at least 10 feet. Hesitate to demonstrate completion of the pattern.

## Reining Pattern #5

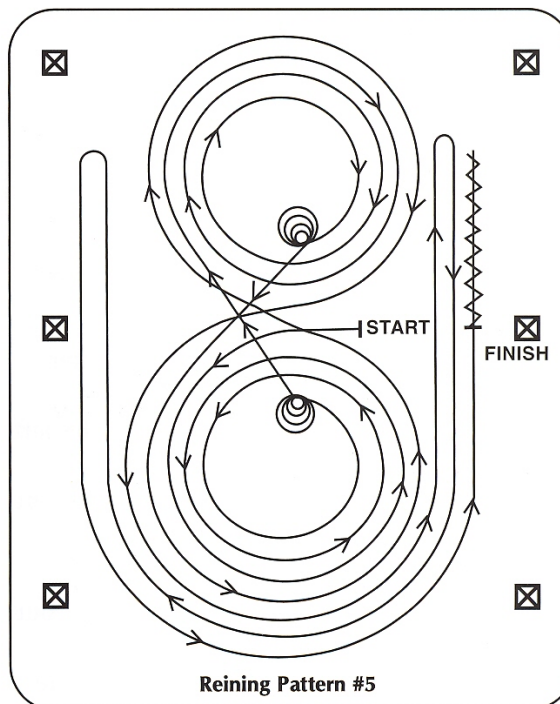

Beginning at the center of the arena facing the left wall or fence.

1. Beginning on the left lead, complete three circles to the left: the first two circles large and fast; the third circle small and slow. Stop at the center of the arena.
2. Complete four spins to the left. Hesitate.
3. Beginning on the right lead, complete three circles to the right: the first two circles large and fast; the third circle small and slow. Stop at the center of the arena.

4. Complete four spins to the right. Hesitate.
5. Beginning on the left lead, run a large fast circle to the left, change leads at the center of the arena, run a large fast circle to the right, and change leads at the center of the arena.
6. Continue around previous circle to the left but do not close this circle. Run up the right side of the arena past the center marker and do a right rollback at least 20 feet from the wall or fence – no hesitation.
7. Continue around previous circle to the right but do not close this circle. Run up the left side of the arena past the center marker and do a left rollback at least 20 feet from the wall or fence.
8. Continue back around previous circle to the left but do not close this circle. Run up the right side of the arena past the center marker, and do a sliding stop at least 20 feet from the wall or fence. Back up at least ten feet. Hesitate to demonstrate completion of the pattern.

1. Walk to the center of the arena; the horse should be facing the left wall or fence.
2. Complete four spins to the right.
3. Complete four spins to the left.
4. Beginning on the left lead, complete three circles to the left: the first two circles large and fast; the third circle small and slow. Change leads at the center of the arena.
5. Complete three circles to the right: the first two circles large and fast; the third circle small and slow. Change leads at the center of the arena.
6. Begin a large fast circle to the left but do not close this circle. Run up the right side of the arena past the center marker and do a right rollback at least 20 feet from the wall or fence – no hesitation.
7. Continue back around the previous circle to the right but do not close this circle. Run up the left side of the arena past the center marker and do a left rollback at least 20 feet from the wall or fence – no hesitation.

## Reining Pattern #6

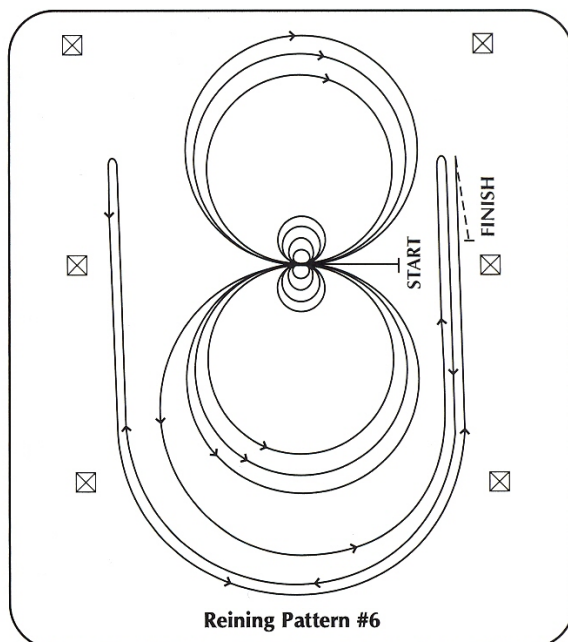

8. Continue back around the previous circle to the left but do not close this circle. Run up the right side of the arena past the center marker and do a sliding stop at least 20 feet from the wall or fence. Back up at least 10 feet. Hesitate, to demonstrate a completion of the pattern.
9. The bridle may be dropped at the judge's discretion.

## Reining Pattern #7

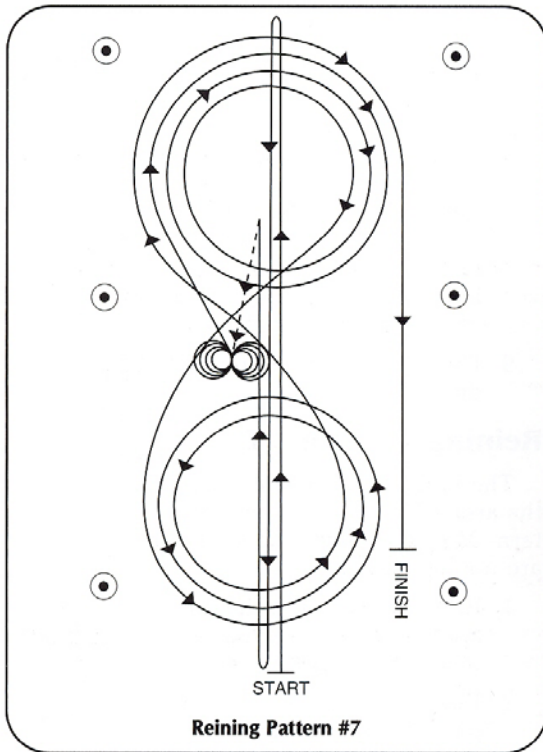

The judge shall indicate with markers on the arena fence or wall the length of the pattern. Markers within the area of the pattern are not permitted.

1. Run with speed to the far end of the arena past the end marker and do a left rollback. Do not hesitate.
2. Run to the opposite end of the arena past the end marker and do a right rollback. Do not hesitate.
3. Run past the center marker of the arena, do a sliding stop, and back straight to the center of the arena. Hesitate.
4. Complete four spins to the right.
5. Complete four and one-quarter spins to the left. Hesitate.
6. Beginning on the right lead, complete three circles to the right, the first two circles large and fast, the third circle

small and slow. At the center of the arena, change leads.

7. Complete three circles to the left, the first two circles large and fast, the third circle small and slow. At the center of the arena, change leads.
8. Begin a large fast circle to the right. Do not close this circle, but run straight down the side of the arena past the center marker and do a sliding stop approximately 20 feet from the wall or fence. Hesitate, to demonstrate the completion of the pattern.
9. The bridle may be dropped at the judge's discretion.

## Reining Pattern #8

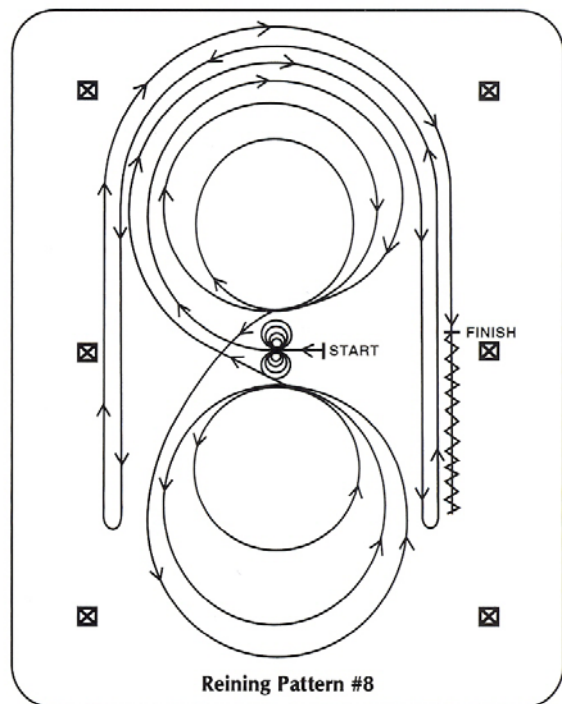

Beginning at the center of the arena facing the left wall or fence.

1. Complete four spins to the left.
2. Complete four spins to the right. Hesitate.

3. Beginning on the right lead, complete three circles to the right: the first circle large and fast; the second circle small and slow; the third circle large and fast. Change leads at the center of the arena.
4. Complete three circles to the left: the first circle large and fast; the second circle small and slow; the third circle large and fast. Change leads at the center of the arena.
5. Begin a large fast circle to the right but do not close this circle. Run straight down the right side of the arena past the center marker and do a left rollback at least 20 feet from the wall or fence – no hesitation.
6. Continue back around the previous circle to the left but do not close this circle. Run down the left side of the arena past the center marker and do a right rollback at least 20 feet from the wall or fence – no hesitation.
7. Continue back around the previous circle to the right but do not close this circle. Run down the right side of the arena past the center marker and do a sliding stop at least 20 feet from the wall or fence. Back up at least 10 feet. Hesitate to demonstrate completion of the pattern.

## Reining Pattern #9

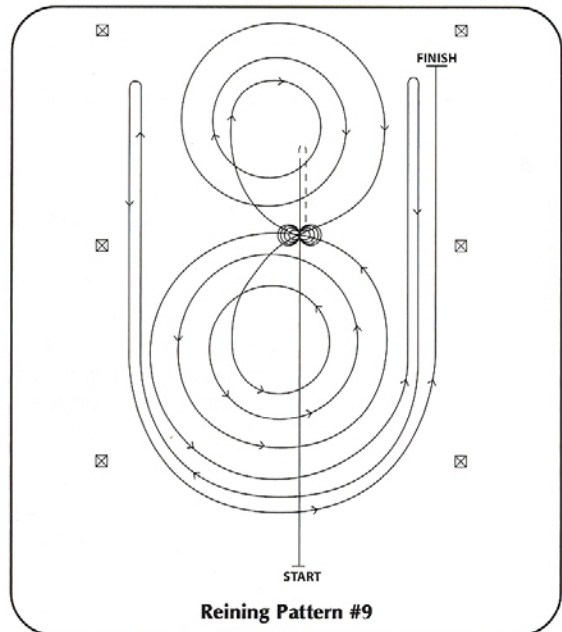

1. Run past the center marker and do a sliding stop. Back up to the center of the arena or at least 10 feet. Hesitate.
2. Complete four spins to the right.
3. Complete four and one-quarter spins to the left so that the horse is facing the left wall or fence. Hesitate.
4. Beginning on the left lead, complete three circles to the left: the first circle small and slow; the next two circles large and fast. Change leads at the center of the arena.
5. Complete three circles to the right: the first circle small and slow; the next two circles large and fast. Change leads at the center of the arena.
6. Begin a large, fast circle to the left but do not close this circle. Run up the right side of the arena past the center marker and do a right rollback at least 20 feet from the wall or fence – no hesitation.

7. Continue back around the previous circle to the right but do not close this circle. Run up the left side of the arena past the center marker and do a left rollback at least 20 feet from the wall or fence – no hesitation.
8. Continue back around previous circle to the left but do not close this circle. Run up right side of the arena past the center marker and do a sliding stop at least 20 feet from the wall or fence. Hesitate to demonstrate completion of the pattern.

## Reining Pattern #10

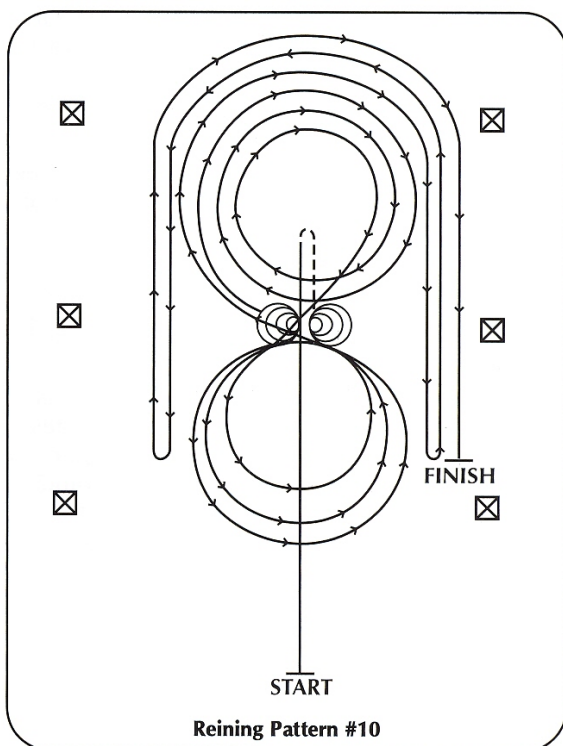

1. Run past the center marker and do a sliding stop. Back up to the center of the arena, or at least 10 feet.
2. Complete four spins to the right.
3. Complete four and one-quarter spins to the left so that the horse is facing the left wall or fence. Hesitate.

4. Beginning on the right lead, complete three circles to the right: the first two circles large and fast, the third circle small and slow. Change leads at the center of the arena.
5. Complete three circles to the left: the first circle small and slow, and the next two circles large and fast. Change leads at the center of the arena.
6. Begin a large fast circle to the right, but do not close this circle. Run down the right side of the arena past the center marker and do a left rollback at least 20 feet from the wall or fence – no hesitation.
7. Continue back around the previous circle to the left but do not close this circle. Run down the left side of the arena past the center marker and do a right rollback at least 20 feet from the wall or fence – no hesitation.
8. Continue back around the previous circle to the right but do not close this circle. Run down the right side of the arena past the center marker and do a sliding stop at least 20 feet from the wall or fence. Hesitate, to demonstrate a completion of pattern.
9. The bridle may be dropped at the judge's discretion.

## Stock Horse Trail

The trail class, as the name implies, tests the horse's ability to cope with many situations encountered in everyday work. The horse is ridden through a pattern of obstacles which should nearly approximate those encountered during the course of everyday work. The horse is judged on the cleanliness, neatness and promptness with which the obstacles are negotiated, ability to negotiate obstacles correctly and attitude and

mannerisms exhibited by the horse while negotiating the course. Emphasis on judging should be on identifying the well-broke, responsive, well-mannered horse which can correctly negotiate the course. The object is not to trap a horse, or eliminate it by making an obstacle too difficult. All courses and obstacles are to be constructed with safety in mind so as to eliminate any accidents.

7. Course will include no less than six and no more than nine obstacles. It is mandatory that the horse be asked to walk, trot and lope during the course.

Walk – can be part of obstacle score and scored with approaching obstacle.

Trot – at least 35 ft and scored with approaching obstacle.

Lope - at least 50 ft and scored with approaching obstacle and be lead specific.

8. Care must be exercised to avoid setting up of any obstacles that may be hazardous to the horse or rider.
9. No extra verbal instructions may be given to the exhibitors by management or a judge that is not written in course description.
10. Judges must walk the course. Judges may remove or change any obstacle they deem unsafe, non-negotiable, or unnecessarily difficult. If any time a trail obstacle becomes unsafe during a class, it shall be repaired or removed from the course. If it cannot be repaired and horses have completed the course, the score for that obstacle shall be deducted from all previous works for that class.
11. The actual trail course cannot be made available to exhibitors or posted prior to the day of competition, but must be posted at least one hour prior to competition.

12. The course may be walked on foot by the exhibitor but no horse/rider exhibitors are allowed on the actual course after it has been set until their trail run begins.

### **Trail Class Obstacle Requirements**

4. Course must be designed using the mandatory obstacles and maneuvers plus optional obstacles. Combining of two or more of any obstacles is acceptable.
5. Prohibited obstacles: Tarps, water obstacles with slick bottoms, PVC pipe used as a jump or walk over, tires, rocking or moving bridges, logs or poles elevated in a manner that permits such to roll in a dangerous manner. Animals (live or stuffed) should only be used which would normally be encountered in a ranch setting and which are not used in an attempt to “spook” a horse.
6. Mandatory obstacles or maneuvers:
  - j. Ride over obstacles on the ground – usually logs or poles. It is recommended that all three gaits (walk, trot, lope) be used, however only two gaits are required.
  - k. Walk-Overs – Walk over no more than five logs or poles. The space between logs for walk-overs should be 20 – 24” apart and no more than 10”high. These can also be in a straight line, curved, zigzagged or raised.
  - l. Trot-Overs – Trot over no more than five logs or poles. The space between trot-overs should be 36-42”. Poles may be elevated a maximum of 10”. These can also be in a straight line, curved, zigzagged or raised.

- m. Lope-Overs – Lope over no more than five poles. The space between lope-overs should be 6' to 7'. Poles may be elevated a maximum of 10". These can also be in a straight line, curved, zigzagged or raised.
- n. Opening, passing through, and closing gate. A gate should be used that will not endanger horse or rider and requires minimum side passing.
- o. Ride over wooden bridge. (Suggested minimum width shall be 36" wide and at least six feet long). Bridge should be sturdy, safe and negotiated at a walk only. Heavy plywood lying flat on the ground is an acceptable simulation of a bridge.
- p. Backing obstacles – Backing obstacles are to be spaced a minimum of 28" spacing. If elevated, 30" spacing is required. Back through and around at least three markers. Back through L, V, U, straight or similar shaped course. May be elevated no more than 24".
- q. Side pass obstacle – Any object which is safe and of any length may be used to demonstrate responsiveness of the horse to leg signals. Raised side pass obstacles should not exceed 12".
- r. Optional obstacles: Following is a list of optional obstacles from which selections can be made, but not limited to:
  - l. Jump - An obstacle whose center height is not less than 14" high or more than 24" high. Holding the saddle horn is permissible for this obstacle
- m. Carry object from one part of the arena to another,
- n. Remove and replace materials from mailbox,
- o. Trot through cones – spacing to be minimum of 6',
- p. Cross Natural ditches or up embankments,
- q. Step in and out of obstacle,
- r. Put on slicker or coat,
- s. Pick-up feet,
- t. Walk through brush,
- u. Ground Tie,
- v. Lead at the trot.

### Scoring Stock Horse Trail

The rider has the option of eliminating any obstacle and taking a score of "0" for the missed obstacle. A judge may ask a horse to pass on an obstacle after three refusals or for safety concerns. Each obstacle will be scored 1-10.

### Trail Credits:

Credit is given to horses negotiating the obstacles with style and some degree of speed, providing correctness is not sacrificed. Horse should receive credit for showing attentiveness to obstacles and capability of picking their own way through the course when the obstacles warrant it, and willingly responding to the rider's cues on more difficult obstacles. Quality of movement and

cadence should be considered part of the maneuver score for the obstacle.

### **Trail Deductions:**

14. Artificial appearance and/or unnecessary delay while approaching or going through obstacles.
15. Each tick of an obstacle.
16. Break of gait at walk or jog.
17. Placing both front or hind feet in a single-strided slot or space.
18. Skipping over or failing to step into a required space.
19. Split pole in lope-over.
20. Stepping on a log, pole, cone or obstacle.
21. Wrong lead or breaking gait at lope.
22. Stepping outside the confines of; falling off or out of an obstacle such as a back thru, bridge, side pass, box, or water box.
23. Refusals, balk, or attempting to evade an obstacle by shying or backing.
24. Blatant disobedience (kicking out, bucking, rearing, striking).
25. Failure to ever demonstrate correct lead or gait, if designated.
26. Failure to complete obstacle.

**Horses should not be ridden over tarps or plastic of any kind.**

**Exhibitors will not be asked to drag or pull any object.**

## **Drill and Precision Divisions**

This division contains two separate classes: drill and precision riding teams. Teams (in total or in part) may participate in either the drill class or the precision riding class or both.

### **Objectives**

1. To teach boys and girls teamwork.
2. To provide opportunities to demonstrate democratic procedure and group action.
3. To teach horsemanship and horse safety to 4-H members.
4. To provide an organized and supervised activity for 4-H members with horses.

### **Requirements**

1. Youth must be enrolled in 4-H with a horsemanship project and meet all 4-H membership requirements.
2. Horse ownership by the 4-H member is mandatory. Refer to rule 5 on page 7.
3. Mounted teams must establish membership requirements with a specific program of teaching and practice. Youth must meet all requirements of the mounted team of which they are members.
4. **All riders on a team must be from the same county.**

### **Organization**

1. Mounted teams may be formed from existing project groups, horse clubs, and/or other 4-H members with horse projects.

2. More than one team may come from a single county.
3. One adult leader will be selected as the team master. Assistants to the team master may be appointed.
4. The 4-H members may elect a team captain and other officers as needed.

6. A fall of the horse and/or rider (each occurrence) will result in a **Five-point penalty**, to be subtracted from the total score.
7. A collision – **Five-point penalty**. A collision is defined when two horses actually collide with each other causing a change in speed and/or direction or stopping the maneuver.

## Drill Class

1. **The use of props by drill teams is prohibited at the district and state shows. There will be no pyrotechnics or smoke of any kind.**
2. **No pre-recorded introductory commentary will be allowed prior to or during the drill competition. Each team will be introduced by the announcer prior to the performance.**
3. Each drill routine should be no longer than 10 minutes. Two points will be deducted from each judge's score card for each minute the drill routine exceeds the 10 minutes. At least 3 seconds of each minute over 10 minutes must be consumed before the penalty is assessed. The 10-minute allowance begins when the first horse enters the arena and ends when the last horse leaves the arena. Time consumed as a result of an accident or other unforeseen circumstances that require stopping the drill is not counted as part of the 10-minute time allowance.
4. Teams shall be composed of no fewer than 10 members and no more than 20 members. (Teams may have larger membership, but routines will be developed for these minimum and maximum numbers of members.)
5. Drills will be judged as a group, with credit given for horsemanship, precision of execution, difficulty of drill, and appeal to audience.

## Drill Team Score Sheet

Drill teams will be scored on the following 40 point system.

Precision of Execution (alignment of files and ranks, maintenance of distances, intervals and gaits).....14

Horsemanship (position in saddle and control of mount) .....12

Difficulty of Drill (intricacy and variety of maneuvers, speed/gait variation, spacing) .....8

Appeal to Audience (entry/exit, theme, uniformity, uniform/equipment, originality, music, showmanship, choreography) .....6

## Precision Riding Teams

1. All precision riding teams will ride the same standard routine found in the State 4-H Horse Show Rules. See figure on pages 75-78. No time limits will be placed on this routine; however, the standard routine will be designed to be completed in less than 15 minutes. **Standard background music WILL NOT be provided for all teams. Music MUST BE an instrumental piece.**
2. **No pre-recorded introductory commentary will be allowed prior to the precision competition. Each team will be introduced by the announcer prior to the performance.**
3. The standard Western dress will be casual pants (blue jeans, denim, cotton,

etc.: no dress pants are allowed) and a plain white shirt or blouse. The standard hunter dress will be breeches or jodhpurs, a hunter-type blouse or shirt, a hunter-type hat, and boots. Coats should not be worn.

4. No matching coats, vests, sweaters, etc., are allowed.
5. The following items may match, but matching items are not required.
  - a. Hats, ties, or neck scarves for riders.
  - b. Leg wraps, saddle blankets, bridles, and breast collars for horses.
6. The precision riding team shall be composed of no fewer than eight members and no more than 20 (all in multiples of four).

### Precision Riding Score Sheet

The whole group will be judged based on horsemanship ability (45), precision of execution of standardized routine (45), and team appearance (10).

### Precision Riding Pattern

1. Riders enter the arena in pairs at a trot. The riders trot down the middle of the arena. At the center of the arena, riders will split and two-track to the wall. Once on the wall they will continue down the side at a trot to the end of the arena.

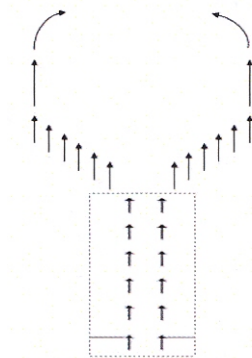

2. The riders will turn right or left in lines, pairing back up in the center and trotting down the center of the arena. Once the group is in paired lines, centered in the middle of the arena, they will stop as a group.

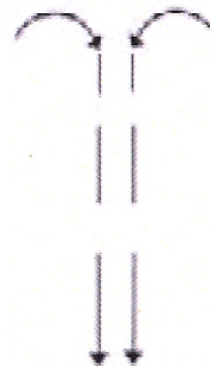

- The riders will simultaneously make a pivot (270 degrees) away from the middle of the arena.

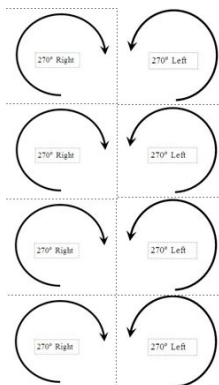

- The horses back four steps simultaneously.

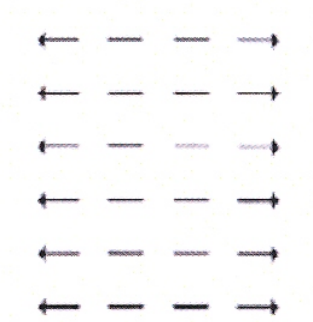

- At a trot, the two lines of riders ride forward, passing between each other, and continue to the rail. Upon reaching the rail, the riders turn left and form single-file lines on the rail.

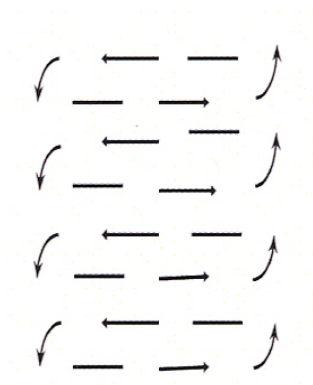

- Upon reaching the opposite ends of the arena, the riders will proceed at a lope into interlocking circles and complete two full circles.

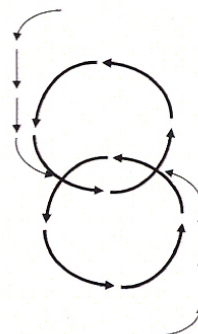

- After completing the two interlocking circles, the riders break the interlocking circles, ride to the rail at a lope, turn to the left down the rail, at the end of the arena slow to a trot, cross the end of the arena, and trot to the opposite rail.

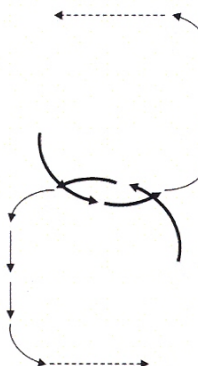

8. The lead rider, upon reaching the rail, slows to a walk, with each successive rider riding forward with his or her horse's head at the preceding rider's knee, forming a walking diagonal line down  $\frac{1}{2}$  the length of the arena.

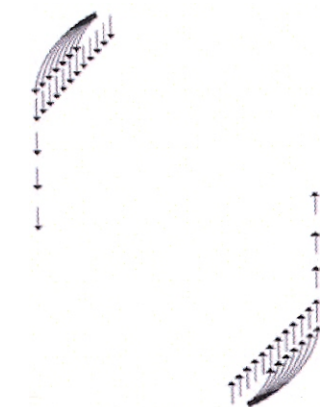

9. When the rider closest to center of the arena reaches center, the riders will turn in succession toward the middle of the arena, thus forming a straight line. Upon reaching the middle of the arena, the riders will line up in a close side by side line stop and hesitate.

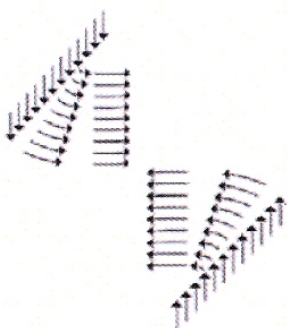

10. The riders execute one full turn (360 degrees).

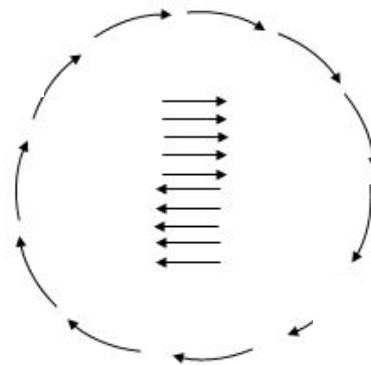

11. After completing one full circle, the designated rider leads the team into a figure eight, being sure to pass to the inside of the circle. The team completes one full figure eight at a lope and a second figure eight at a canter.

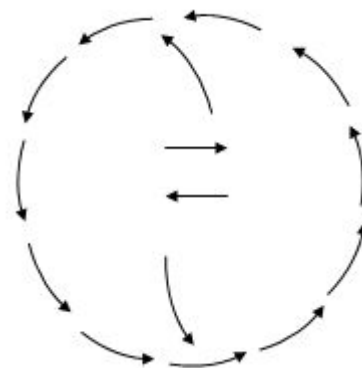

12. The lead rider, after completion of the second figure eight, rides to the rail, turns to the right, slows to a trot, trots down the rail, to the end of the arena.

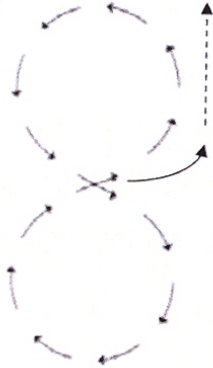

13. Upon reaching the end of the arena, the riders slow to a trot and form groups four abreast. The groups of four ride down the middle of the arena. When all the groups of four are formed, the groups should be head to tail alignment.

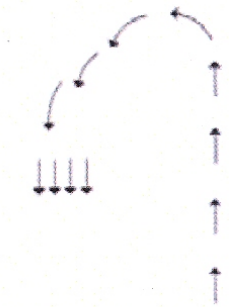

14. All riders trot through the center of the arena.

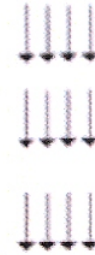

15. Upon reaching the end of the arena, all riders stop. Middle pair of riders file out of the arena in pairs at a walk.

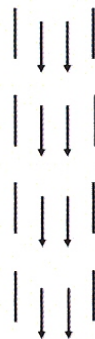

16. When the first section has exited, the remaining outside riders will side pass into the center and then exit at a walk.

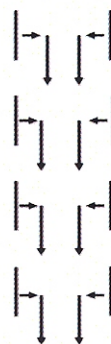

## **Texas Equine Liability Law**

The Texas Legislature passed a liability law, effective September 1, 1995. The law defines terms associated with equine activities and the people involved and includes a warning. It also requires that a sign stating the warning be posted in a clearly visible location where equine activities take place. Post this sign at all locations where 4-H riding practices and competitive events are to be held.

## **Warning**

**Under Texas Law (Chapter 87, Civil Practice and Remedies Code), and Equine professional is not liable for an injury to or the death of a participant in equine activities resulting from the inherent risk of equine activities.**

Produced by Extension Horse Specialists, Texas AgriLIFE Extension Service, Department of Animal Science, The Texas A&M System.

**Official Publication # AS 3-2.043  
(Revised Internally 2/2010)**

*Educational programs of Texas AgriLIFE Extension Service are open to all people without regard to race, color, sex, disability, religion, age, or national origin.*

Issued in furtherance of Cooperative Extension Work in Agriculture and Home Economics, Acts of Congress of May 8, 1914, as amended, and June 30, 1914, in cooperation with the United State Department of Agriculture. Edward G. Smith, Director, Texas Cooperative Extension. Revision